

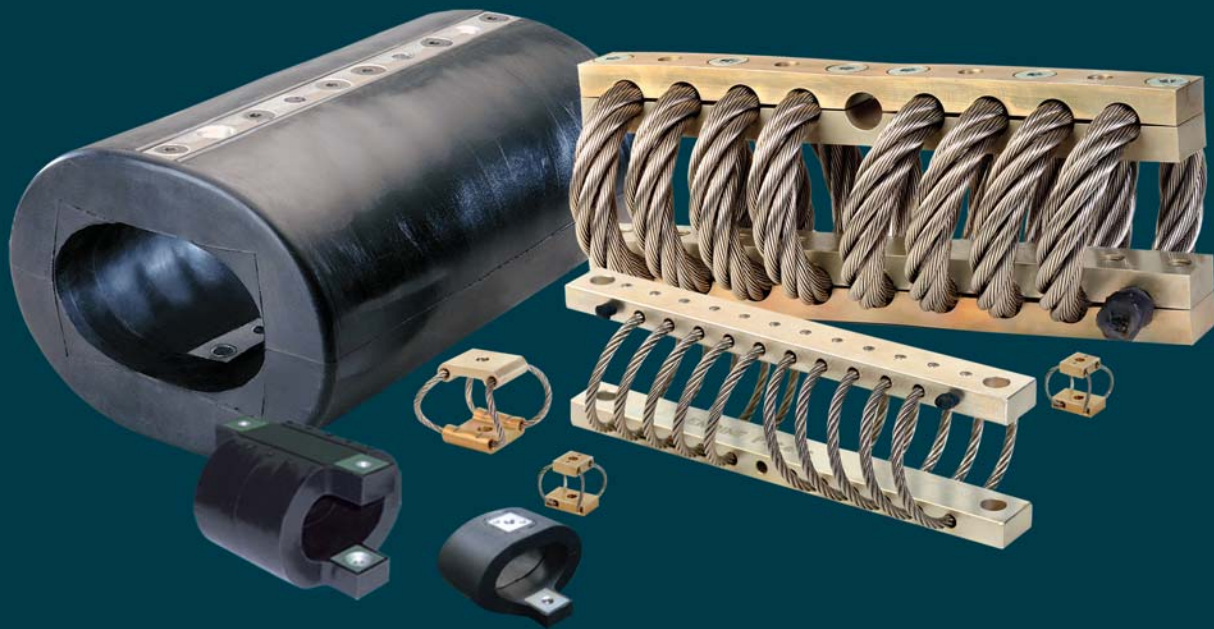

ITT

Wire Rope Isolator Technologies



Engineered for life

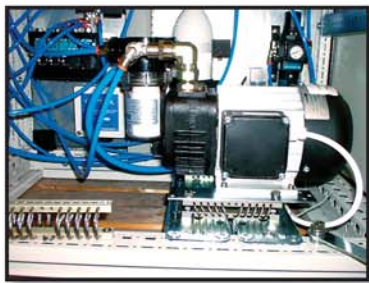

WR and HERM Applications:

- Carts, Transporters & Gurneys
- Chemical Processing Equipment
- Chimneys, Scrubbers & Vessels
- Electronic Cabinets
- Navigation Equipment
- Over-the-road Transport
- Power Plant Piping Suspension
- Pump, Generator & Compressor Isolation
- Seismic Isolation
- Shipping Cases, Skids & Containers
- Transportable Shelters

CR Applications:

- Audio/Visual Equipment
- Catering Carts
- Communications Packages
- Medical Devices
- Sensitive Electronic Equipment
- Security Cameras
- Hard Drives / CD-ROM Drives
- Electronics Production

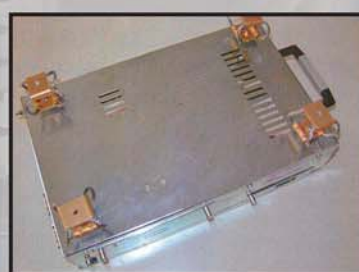

Table of Contents

Product Selection

Company Overview	1	General
New Technologies and Enhancements	2	

Standard Wire Rope Products



Wire Rope Isolators

Overview	3-4	WR
Sizing Information/Application Worksheet	5-6	
WR Technical Data	7-34	



Compact Wire Rope Isolators

Overview	35-36	CR
Sizing Information/Application Worksheet	37-38	
CR Technical Data	39-50	



HERM (High Energy Rope Mounts)

Overview	51-52	HR
Sizing Information/Application Worksheet	53-54	
HR Technical Data	55-68	

Custom Engineered Products

WEAR™ Pipe Restraints Overview	69	Custom
Wire Mesh Isolator Overview	70	

Enidine, a preferred source for energy absorption and vibration isolation solutions, offers a full range of Wire Rope, Compact Wire Rope Isolator and HERM (High Energy Rope Mount) products, each designed to reduce the harmful effects of shock and vibration.



U.S. Patents 5,549,285
6,290,217
6,244,579

Need Assistance? Enidine is ready to answer your questions, feel free to contact us at:

Phone: Toll Free - 1.800.852.8508
Direct - 1.716.662.1900

Fax: General - 1.716.662.1909
Industrial - 1.716.662.0406
Aerospace - 1.716.662.1385

Email: industrialsales@enidine.com
aviationsales@enidine.com
defensesales@enidine.com

Online: www.enidine.com



With its world headquarters located in Orchard Park, New York, USA, **ENIDINE Incorporated** is a world leader in the design and manufacture of standard and custom energy absorption and vibration isolation product solutions within the Industrial, Aerospace, Defense, Marine and Rail markets. Product ranges include shock absorbers, gas springs, rate controls, air springs, wire rope isolators, heavy industry buffers and emergency stops. With facilities strategically located throughout the world and in partnership with our vast global network of distributors, Enidine Incorporated continues to strengthen its presence within marketplace.

Founded in 1966, Enidine Incorporated now has close to 600 employees located throughout the globe in the United States, Germany, France, Japan, China and Korea. With a team of professionals in engineering, computer science, manufacturing, production and marketing our employees provide our customers the very best in service and application solutions.

“Enidine is widely recognized as the preferred source for energy absorption and vibration isolation products.”

From Original Equipment Manufacturers (OEM) to aftermarket applications, Enidine offers a unique combination of product selection, engineering excellence and technical support to meet even the toughest energy absorption application requirements.

Global Manufacturing and Sales Facilities offer our customers:

- **Highly Trained Distribution Network**
- **State-of-the Art Engineering Capabilities**
- **Custom Solution Development**
- **Customer Service Specialists**
- **Multiple Open Communication Channels**

If you are unsure whether one of our standard products meets your requirements, feel free to speak with one of our technical representatives **toll-free at 1-800-852-8508**, or contact us via **e-mail at industrialsales@enidine.com**.

Products/Engineering/Technical Support

Enidine continually strives to provide the widest selection of shock absorbers and rate control products in the global marketplace. Through constant evaluation and testing, we bring our customers the most cost effective products with more features, greater performance and improved ease of use.

Enidine engineers continue to monitor and influence trends in the motion control industry, allowing us to remain at the forefront of new energy absorption and vibration isolation product development.

Our experienced engineering team has designed custom solutions for a wide variety of challenging applications, including automated warehousing systems and shock absorbers for hostile industrial environments such as glass manufacturing, among others. These custom application solutions have proven to be critical to our customers' success. Let Enidine engineers do the same for you.



Custom designs are not an exception at Enidine, they are an integral part of our business. Should your requirements fit outside of our standard product range, Enidine engineers can assist in developing special finishes, components, hybrid technologies and new designs to ensure a "best-fit" product solution customized to your exact specifications.

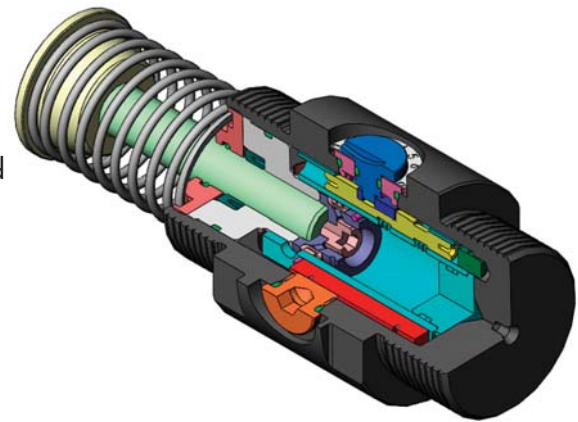

A talented engineering staff works to design and maintain the most efficient energy absorption product lines available today, using the latest engineering tools:

- **Solid Modeling**
- **3-D CAD Drawings**
- **3-D Soluble Support Technology**
- **Finite Element Analysis**
- **Complete Product Verification Testing Facility**

New product designs get to market fast because they can be fully developed in virtual environments before a prototype is ever built. This saves time and lets us optimize the best solution using real performance criteria.

Global Service and Support

Enidine offers its customers a global network of customer service staff technical sales personnel that are available to assist you with all of your application needs.

- Operating with lean manufacturing and cellular production, Enidine produces higher quality custom and standard products with greater efficiency and within shorter lead times.
- An authorized Global Distribution Network is trained regularly by ENIDINE staff on new products and services ensuring they are better able to serve you.
- Global operations in United States, Germany, France, China, Japan and Korea.
- A comprehensive, website full of application information, technical data, sizing examples and information to assist in selecting the product that's right for you.

Our website also features a searchable worldwide distributor lookup to help facilitate fast, localized service. Contact us today for assistance with all of your application needs.



Our global customer service and technical sales departments are available to assist you find the solution that's right for your application needs. Call us at 1.800.852.8508 or e-mail us at industrialsales@enidine.com and let us get started today.



U.S. Patents 5,549,285

Wire Rope Isolators

Standard Wire Rope Isolators are comprised of stainless steel stranded cable threaded through aluminum alloy retaining bars that are mounted for effective shock and vibration isolation. With their corrosion resistant, all-metal construction, Enidine Wire Rope Isolators are environmentally stable, high-performance shock and vibration isolators that are unaffected by temperature extremes, chemicals, oils, ozone and abrasives.

Featuring a patented crimping pattern, versatile mounting options and a variety of sizes, these helical isolator products can help ensure that your systems can effectively meet performance requirements in Commercial, Industrial, and Defense industries, including MIL-STD-810, MIL-STD-167, MIL-S-901D, MIL-E-5400, STANAG-042, BV43-44 and DEF-STND 0755. For more information, please refer to our "Wire Rope Isolator Sizing Information" on pages 5-6 to assist you in selecting a model for your application.

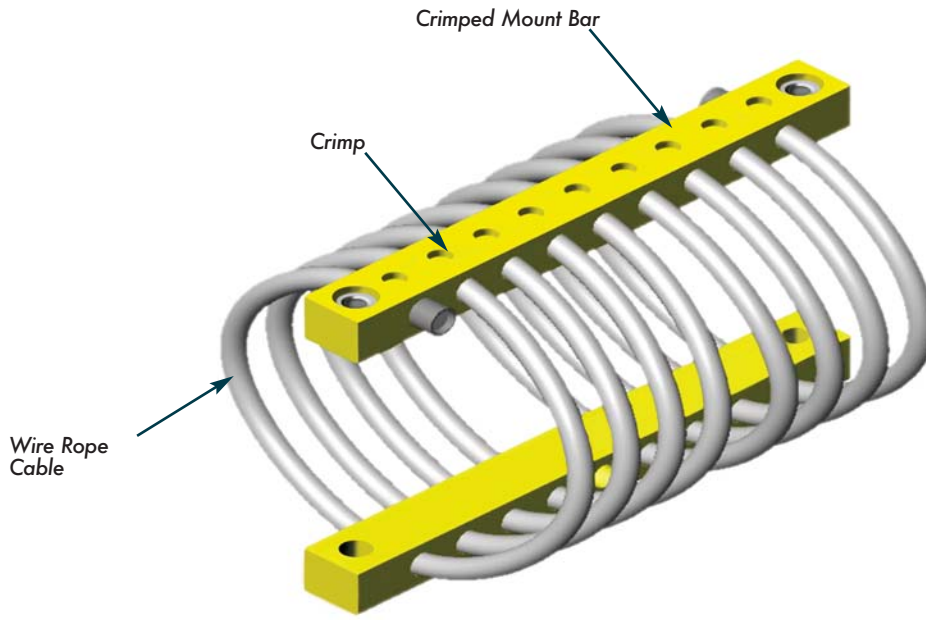

Crimp Models (WR2 – WR8):

Enidine's patented crimp design lowers cost by using fewer mount bars when compared to the clamp design, no assembly hardware, and reduced assembly time.

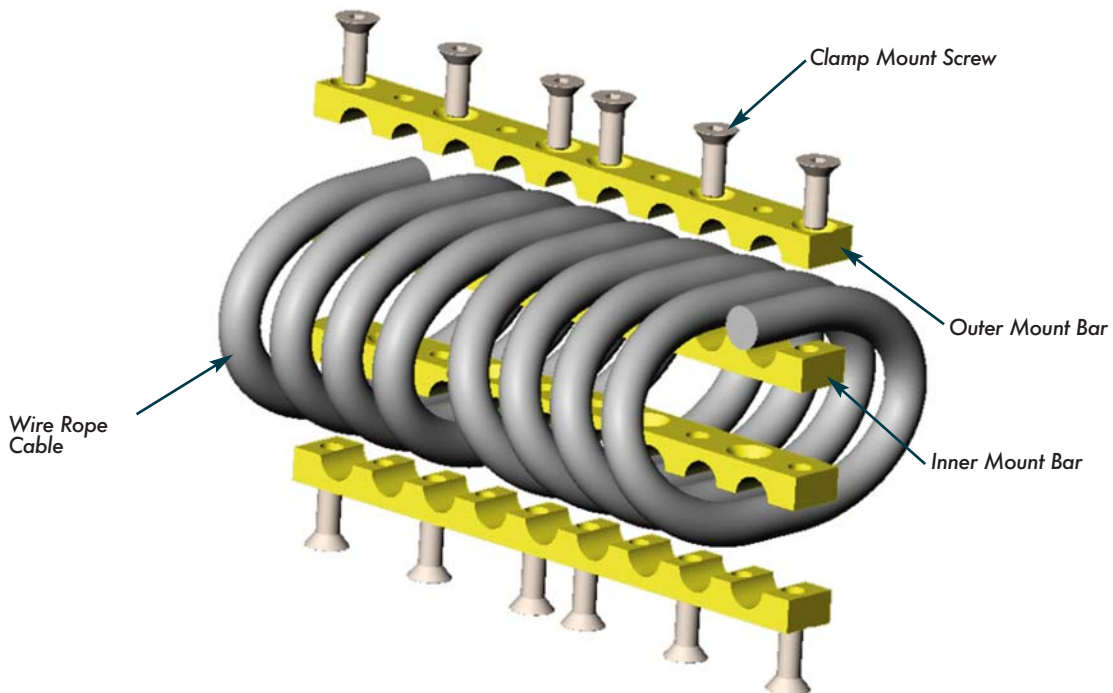

Clamp Models (WR12 – WR40):

Enidine's clamp bar models are constructed by clamping the wire rope between two fastened mount bars.

Materials and Finishes:

Standard: Wire Rope: 302/304 Stainless Steel
 Mount Bars: 6061-T6 Aluminum, Chemical Conversion Coated per MIL-C-5541, Class 1A
 Hardware: Alloy Steel per ASTM F835, Zinc Plated (WR12–WR40 Series)
 Thread: Stainless Self Clinching Insert (WR2–WR8 Series), Threaded Bar (WR12–WR40 Series)

Optional: Wire Rope: Galvanized or Nylon Coated Stainless
 Mount Bars: 6061-T6 Aluminum, Anodized per MIL-A-8625, Type II, Class 1
 302/304 Stainless Steel per ASTM A276, Passivated
 Hardware: 302/304 Stainless Steel (when stainless steel bars are specified) (WR12 – WR40)
 Threads: Stainless Steel Helical Inserts, Free Running or Self Locking (WR3 – WR40)
 Threaded Aluminum (WR2 – WR8)

Special: Consult Enidine

Isolator Options:

Mounting: Enidine offers a full range of mounting combinations of thru-hole, countersunk, and threaded bars. All configurations are available in either Imperial or Metric styles. Add an "M" after the mounting option for Metric. Some models have reduced mounting options available due to limited fastener installation space. Consult Enidine if a preferred mounting configuration is not listed.

Loops: Enidine's wire rope isolators can be purchased with the full number of loops, or as few as 2-Loops. The number of loops is indicated in the isolator part number. Performance is provided for full loop isolators. Performance for reduced loop isolators can be obtained by a simple ratio.

Bellmouth: Enidine's wire rope isolators are available with a "bellmouth" option. The bellmouth feature includes mount bars with radii manufactured into the wire rope hole edges. This option is recommended for high fatigue applications. Add an "R" to the end of the part number.

Performance:**Stiffness (Kv or Ks):**

Wire rope isolators exhibit non-linear stiffness behavior. Small deflections, usually associated with vibration isolation, will have a different spring rate than larger shock deflections. Enidine publishes typical vibration stiffness values (Kv), and average shock stiffness values (Ks) within the catalog. These values can be used with the provided equations listed on Page 6 to predict system performance. The stiffness values listed in the catalog are for full-loop versions. For reduced loop versions, ratio the stiffness by dividing the number of desired loops by the number of full loops.

Isolator Axes:

Wire rope isolators are multi-axis isolators. The diagram below includes load axis definitions and deflection considerations.

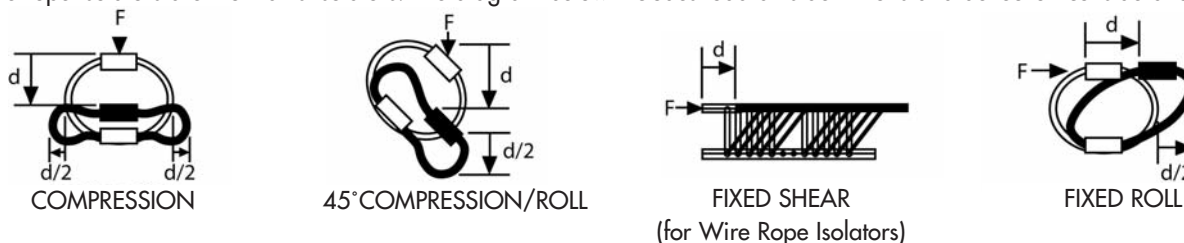

Damping: Typically 5-15%, depending on size and input level. For specific damping considerations, please consult Enidine.

Mounting Orientation:

The diagrams below illustrate typical mounting orientations.

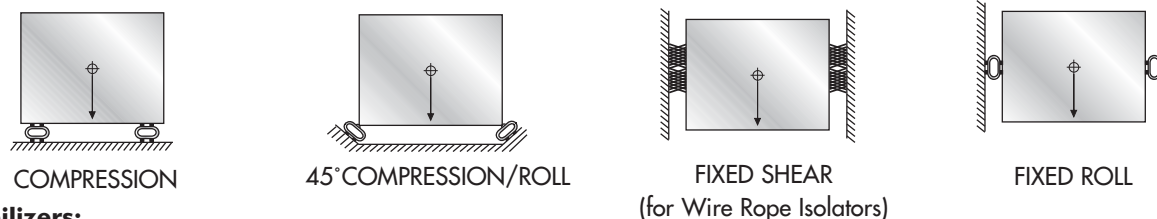
**Stabilizers:**

Stabilizers are used to control deflections of tall supported masses. Stabilizers are typically recommended when the height equals 2-times the width or depth dimension. In most applications, the quantity of stabilizers required are half as many as the base isolators, and selected one size softer than the base isolators.

APPLICATION WORKSHEET - INPUTS IMPERIAL/METRIC		IMPERIAL	METRIC
PART I: SYSTEM DATA:			
1. Total Supported Load (W _T):	W _T = _____ lbs. W _T = _____ Kg x 9.81 = _____ N		
2. Number of Isolators (n):	n = _____		
3. Static Load per Isolator (W):	W = $\frac{W_T}{n}$	W = _____ lbs.*	W = _____ N*
* Assumes a central CG			
4. Load Axis: Compression Shear or Roll 45° Compression/Roll		Load Axis _____	Load Axis _____
PART II: VIBRATION SIZING:			
1. Input Excitation Frequency	(f _i) = _____ Hz (= $\frac{rpm}{60}$)		
2. System Response Natural Frequency for 80% isolation:	f _n = $\frac{f_i}{3.0}$ = _____ Hz		
3. Maximum Isolator Vibration Stiffness: (K _v)	K _v = $\frac{W (2\pi f_n)^2}{g}$ g = 386 in./sec ² or 9.81 m/sec ²	K _v = _____ lbs./in.	K _v = _____ N/m
4. Select an isolator by comparing calculated values with technical data for the desired load axis provided in tables for each isolator. a.) Calculated "W" must be less than the isolator's max static load and b.) Isolator's vibration stiffness must be less than the calculated maximum K _v			
PART III: SHOCK SIZING:			
1. Maximum Allowable Transmitted Acceleration:	A _T = _____ G's		
2. Shock Input Velocity:	V = _____ in./sec. V = _____ m/sec.		
Free Fall Impact:	V = $\sqrt{2gh}$ g = 386 in./sec. ² or 9.81 m/sec. ² h = Drop Height (in. or m)		
3. Min. Isolator Response Deflection:	D _{min} = $\frac{V^2}{g(A_T)}$	D _{min} = _____ in.	D _{min} = _____ m
4. Maximum Isolator Shock Stiffness:	K _s = $\frac{W(V/D_{min})^2}{g}$	K _s = _____ lbs./in.	K _s = _____ N/m
5. Select an isolator by comparing calculated values with technical data for the desired load axis provided in tables for each isolator. a.) Calculated "W" must be less than the isolator's max static load and b.) Calculated D _{min} must be less than the isolator's max deflection Note: Metric deflections are calculated in meters (m) and technical data is in millimeters (mm). and c.) Isolator's shock stiffness must be less than calculated maximum "K _s "			
6. Check actual deflection using "K _s " from technical data to ensure that the isolator's max deflection is not exceeded.	D _{actual} = $\frac{V}{\sqrt{K_s(Isolator)g}}$	D _{actual} = _____ in.	D _{actual} = _____ m
7. If isolator's max deflection is exceeded, select another isolator and repeat steps 5 and 6.			

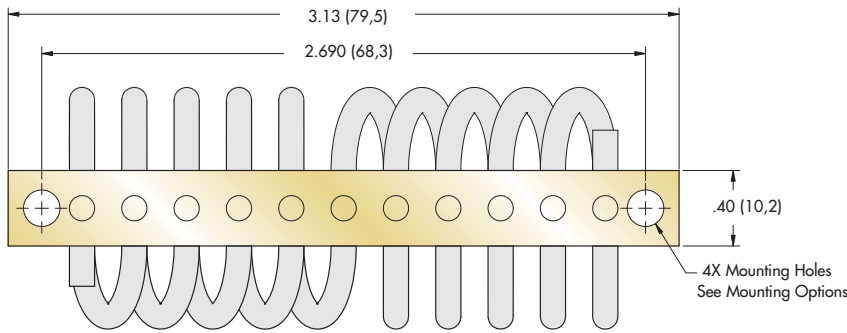

Note: Dimensions are in inches (mm)
Tolerances are ± .010 (± .25mm)

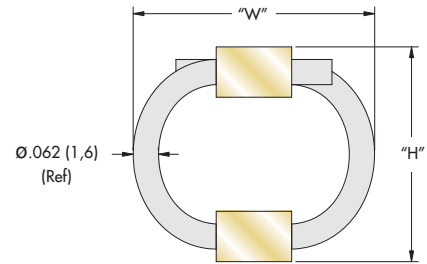
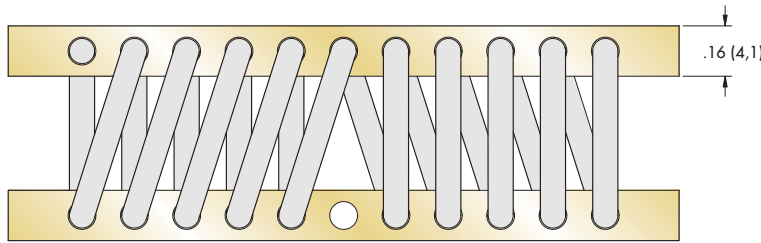

Size	Height "H" in. (mm)	Width (Ref) "W" in. (mm)	Unit Weight Lbs. (Kg)	Mounting Options	Thru Hole in. (mm)	Thread in. (mm)	C'sink Imperial (Metric)
WR2-100	0.70 (18)	1.00 (25)	0.05 (0,02)	B, D, E	Ø.185 ± .005 (Ø4,7 ± 0,13)	#8-32 UNC (M4 X 0,7)	82° (90°)
WR2-200	0.80 (20)	1.10 (28)	0.05 (0,02)	A, B, C, D, E, S			
WR2-400	1.00 (25)	1.20 (30)	0.07 (0,03)				
WR2-600	1.10 (28)	1.30 (33)	0.07 (0,03)				
WR2-700	1.20 (30)	1.40 (36)	0.07 (0,03)				
WR2-800	1.30 (33)	1.50 (38)	0.07 (0,03)				

Model Number Ordering Code

WR2 - 400 - 10 D T M P N R

- Feature Options:
 - *[] - None
 - [R] - Bellmouth Mount Bars
- Wire Rope Options:
 - *[] - 302/304 Stainless Steel (or Equiv.)
 - [G] - Galvanized Steel
 - [N] - Nylon Coated Stainless Steel
- Mount Bar Options:
 - *[] - 6061-T6 AL ALY (or Equiv.) Chem Conv. Coated
 - [Y] - 6061-T6 AL ALY (or Equiv.) Anodized
 - [P] - 302/304 Stainless Steel (or Equiv.) Passivated
- Add "M" for Metric For C'sink and Threaded Options
- Threaded Hole Options:
 - *[] - Flush Self Clinching Threaded Insert
 - [T] - Tapped
- Mounting Options: See Chart
- Number of Loops: 10 (Reduced Number of Loops Available)
- Isolator Size: See Sizing Table

Mounting Options

- Maximum recommended torque for standard threaded insert is 6 in.-lbs. (0,7 Nm)
- Operating Temperature Range: -150°F to 500°F (-100°C to 260°C)
- U.S. Patent 5,549,285

* Standard features. Any non-standard items may require longer lead times. Call for quotation.

Static Load vs. Deflection

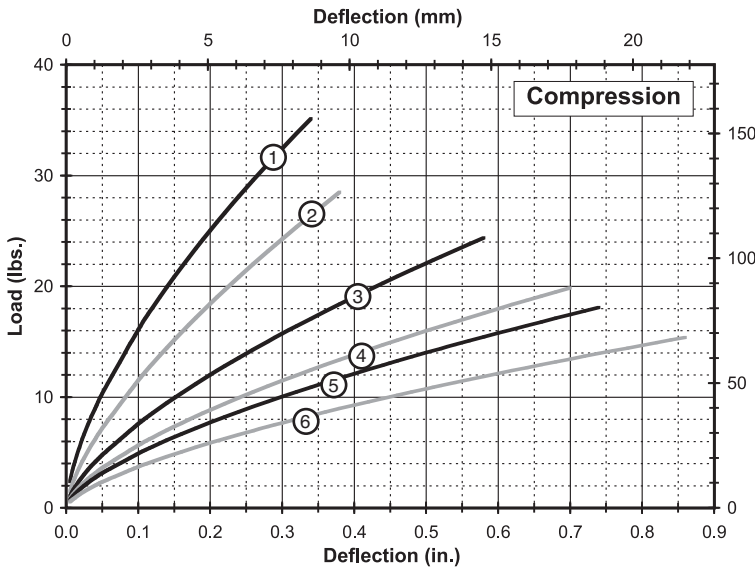

Compression

Curve	Model	Max Static Load Lbs. (N)	Max Deflection in. (mm)	Kv (vibration) Lbs./in. (kN/m)	Ks (shock) Lbs./in. (kN/m)
1	WR2-100-10	10.5 (47)	0.34 (8,6)	205 (36)	125 (22)
2	WR2-200-10	8.0 (36)	0.38 (9,7)	145 (25)	90 (16)
3	WR2-400-10	7.0 (31)	0.58 (14,7)	95 (17)	50 (8,8)
4	WR2-600-10	6.0 (27)	0.70 (17,8)	70 (12)	35 (6,1)
5	WR2-700-10	5.0 (22)	0.74 (18,8)	60 (11)	30 (5,3)
6	WR2-800-10	4.5 (20)	0.86 (21,8)	45 (7,9)	22 (3,9)

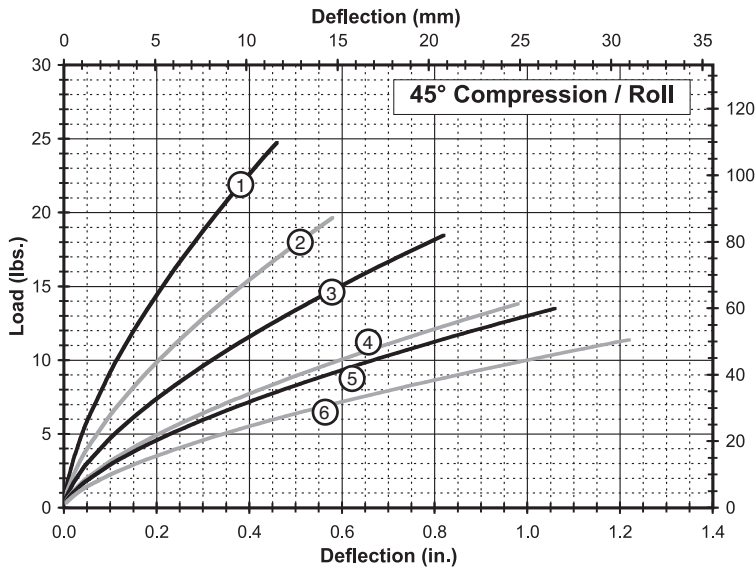

45° Compression/Roll

Curve	Model	Max Static Load Lbs. (N)	Max Deflection in. (mm)	Kv (vibration) Lbs./in. (kN/m)	Ks (shock) Lbs./in. (kN/m)
1	WR2-100-10	7.5 (33)	0.46 (11,7)	115 (20)	65 (11,4)
2	WR2-200-10	5.5 (24)	0.58 (14,7)	80 (14)	40 (7,0)
3	WR2-400-10	5.5 (24)	0.82 (20,8)	60 (11)	27 (4,7)
4	WR2-600-10	4.0 (18)	0.98 (24,9)	40 (7,0)	17 (3,0)
5	WR2-700-10	4.0 (18)	1.06 (26,9)	35 (6,1)	15 (2,6)
6	WR2-800-10	3.5 (16)	1.22 (31,0)	30 (5,3)	11 (1,9)

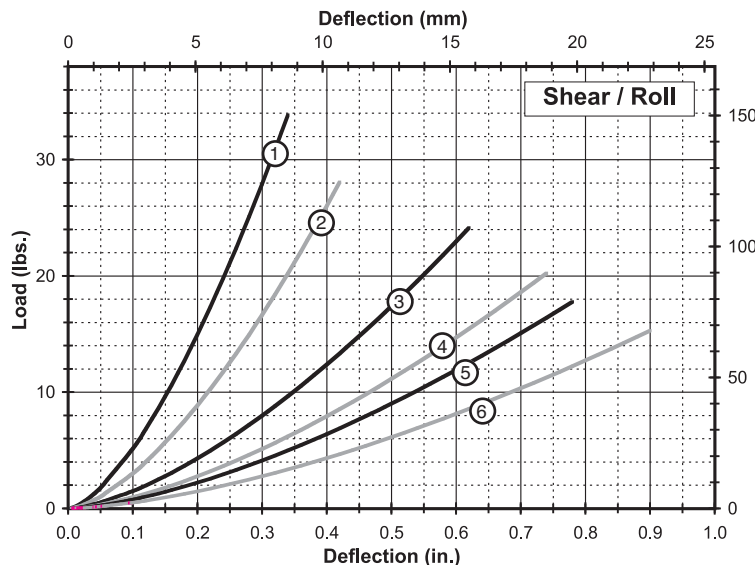

Shear/Roll

Curve	Model	Max Static Load Lbs. (N)	Max Deflection in. (mm)	Kv (vibration) Lbs./in. (kN/m)	Ks (shock) Lbs./in. (kN/m)
1	WR2-100-10	5.0 (22)	0.34 (8,6)	80 (14)	80 (14)
2	WR2-200-10	4.0 (18)	0.42 (10,7)	50 (8,8)	50 (8,8)
3	WR2-400-10	3.5 (16)	0.62 (15,7)	30 (5,3)	30 (5,3)
4	WR2-600-10	3.0 (13)	0.74 (18,8)	22 (3,9)	22 (3,9)
5	WR2-700-10	3.0 (13)	0.78 (19,8)	18 (3,2)	18 (3,2)
6	WR2-800-10	2.5 (11)	0.90 (22,9)	13 (2,3)	13 (2,3)

Note: Performance provided for full loop models with standard (302/304) stainless steel cable. Consult ENIDINE for other options. Do not extrapolate curves.

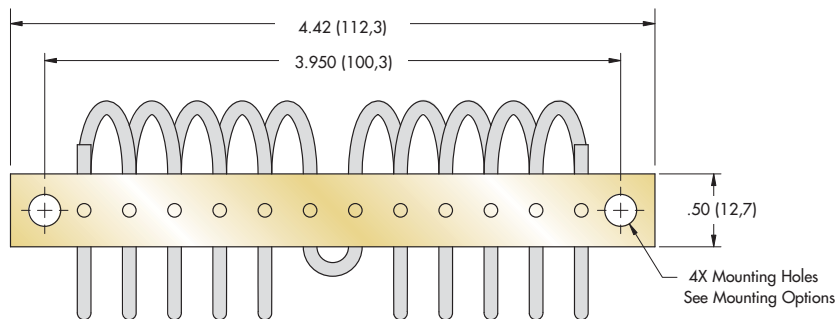

Note: Dimensions are in inches (mm)
Tolerances are ± .010 (± .25mm)

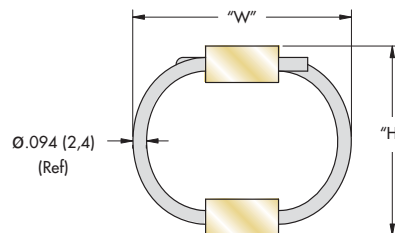
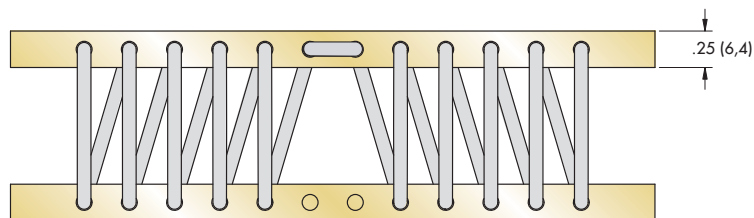

Size	Height "H" in. (mm)	Width (Ref) "W" in. (mm)	Unit Weight Lbs. (Kg)	Mounting Options	Thru Hole in. (mm)	Thread in. (mm)	C'sink Imperial (Metric)
WR3-100	0.90 (23)	1.10 (28)	0.14 (0,06)	B, D, E	Ø.210 ± .005 (Ø5,3 ± 0,13)	#10-32 UNF (M5 X 0,8)	82° (90°)
WR3-200	1.00 (25)	1.20 (30)	0.15 (0,07)	A, B, C, D, E, S			
WR3-400	1.10 (28)	1.30 (33)	0.15 (0,07)				
WR3-600	1.30 (33)	1.50 (38)	0.15 (0,07)				
WR3-700	1.40 (36)	1.60 (41)	0.16 (0,07)				
WR3-800	1.50 (38)	1.70 (43)	0.18 (0,08)				

Model Number Ordering Code

WR3 - 400 - 10 D T M P N R

- Feature Options: * [] - None
[R] - Bellmouth Mount Bars
- Wire Rope Options: * [] - 302/304 Stainless Steel (or Equiv.)
[G] - Galvanized Steel
[N] - Nylon Coated Stainless Steel
- Mount Bar Options: * [] - 6061-T6 AL ALY (or Equiv.) Chem Conv. Coated
[Y] - 6061-T6 AL ALY (or Equiv.) Anodized
[P] - 302/304 Stainless Steel (or Equiv.) Passivated
- Add "M" for Metric For C'sink and Threaded Options
- Threaded Hole Options: * [] - Flush Self Clinching Threaded Insert
[H] - Helical Insert, Free Running
[L] - Helical Insert, Self Locking
[T] - Tapped
- Mounting Options: See Chart
- Number of Loops: 10 (Reduced Number of Loops Available)
- Isolator Size: See Sizing Table

Mounting Options

- Maximum recommended torque for standard threaded insert is 8 in.-lbs. (0,9 Nm)
- Operating Temperature Range: -150°F to 500°F (-100°C to 260°C)
- U.S. Patent 5,549,285

* Standard features. Any non-standard items may require longer lead times. Call for quotation.

Static Load vs. Deflection

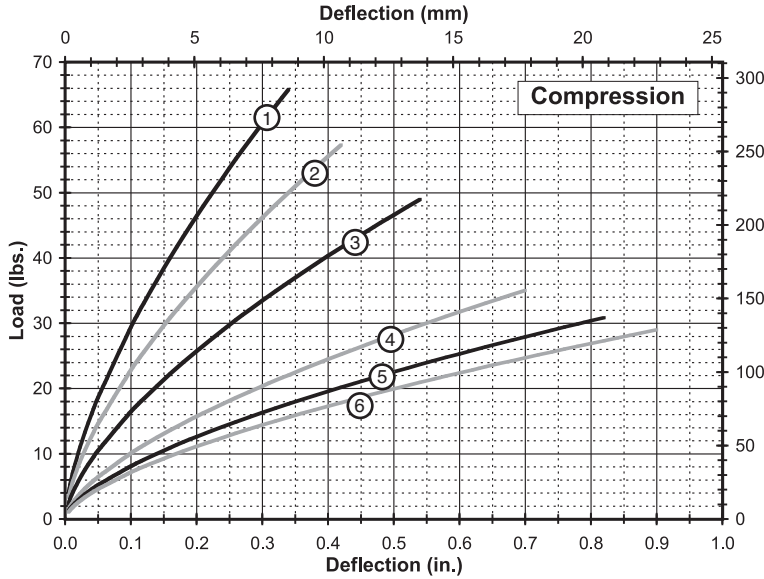

Compression

Curve	Model	Max Static Load Lbs. (N)	Max Deflection in. (mm)	Kv (vibration) Lbs./in. (kN/m)	Ks (shock) Lbs./in. (kN/m)
1	WR3-100-10	19 (85)	0.34 (8,6)	370 (65)	230 (40)
2	WR3-200-10	17 (76)	0.42 (10,7)	290 (51)	170 (30)
3	WR3-400-10	14 (62)	0.54 (13,7)	210 (37)	110 (19)
4	WR3-600-10	10 (44)	0.70 (17,8)	130 (23)	60 (11)
5	WR3-700-10	9 (40)	0.82 (20,8)	105 (18)	45 (7,9)
6	WR3-800-10	9 (40)	0.90 (22,9)	90 (16)	40 (7,0)

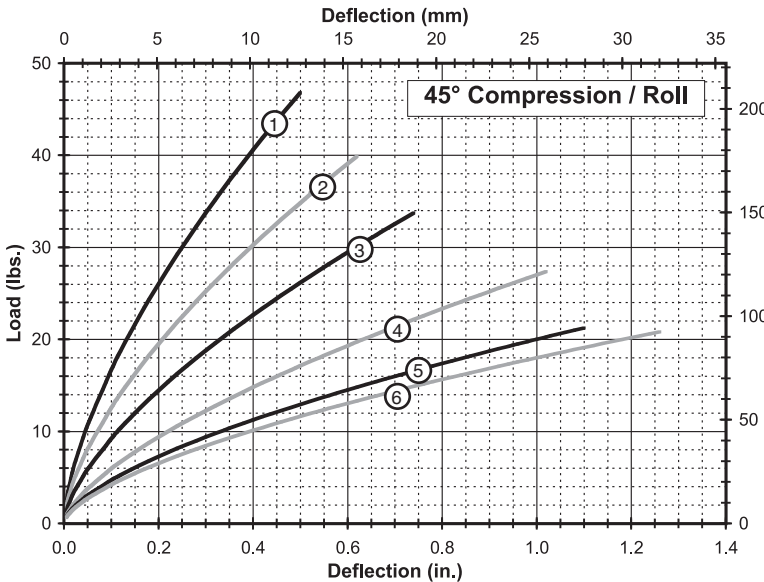

45° Compression/Roll

Curve	Model	Max Static Load Lbs. (N)	Max Deflection in. (mm)	Kv (vibration) Lbs./in. (kN/m)	Ks (shock) Lbs./in. (kN/m)
1	WR3-100-10	14 (62)	0.50 (12,7)	215 (38)	115 (20)
2	WR3-200-10	12 (53)	0.62 (15,7)	160 (28)	80 (14)
3	WR3-400-10	10 (44)	0.74 (18,8)	120 (21)	55 (9,6)
4	WR3-600-10	8 (36)	1.02 (25,9)	75 (13)	32 (5,6)
5	WR3-700-10	7 (31)	1.10 (27,9)	60 (11)	25 (4,4)
6	WR3-800-10	6 (27)	1.26 (32,0)	55 (9,6)	20 (3,5)

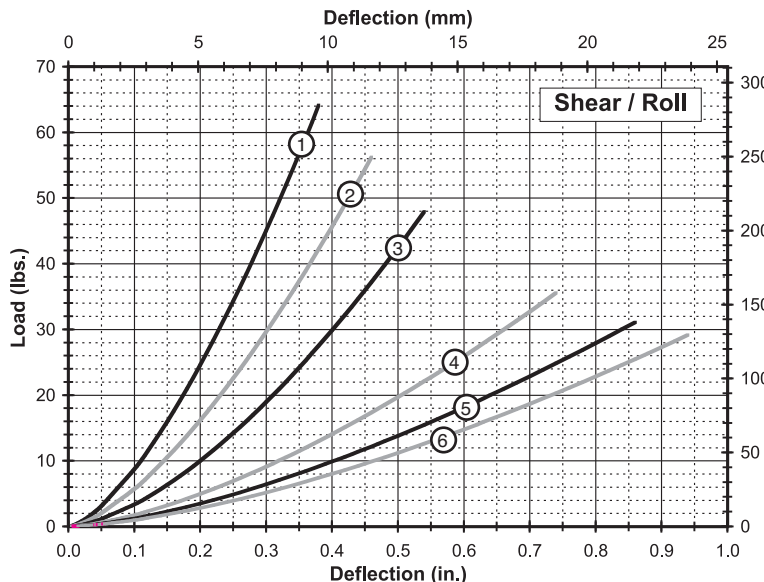

Shear/Roll

Curve	Model	Max Static Load Lbs. (N)	Max Deflection in. (mm)	Kv (vibration) Lbs./in. (kN/m)	Ks (shock) Lbs./in. (kN/m)
1	WR3-100-10	10 (44)	0.38 (9,7)	135 (24)	135 (24)
2	WR3-200-10	9 (40)	0.46 (11,7)	100 (18)	100 (18)
3	WR3-400-10	7 (31)	0.54 (13,7)	70 (12)	70 (12)
4	WR3-600-10	6 (27)	0.74 (18,8)	40 (7,0)	40 (7,0)
5	WR3-700-10	5 (22)	0.86 (21,8)	30 (5,3)	30 (5,3)
6	WR3-800-10	4 (18)	0.94 (23,9)	25 (4,4)	25 (4,4)

Note: Performance provided for full loop models with standard (302/304) stainless steel cable. Consult ENIDINE for other options. Do not extrapolate curves.

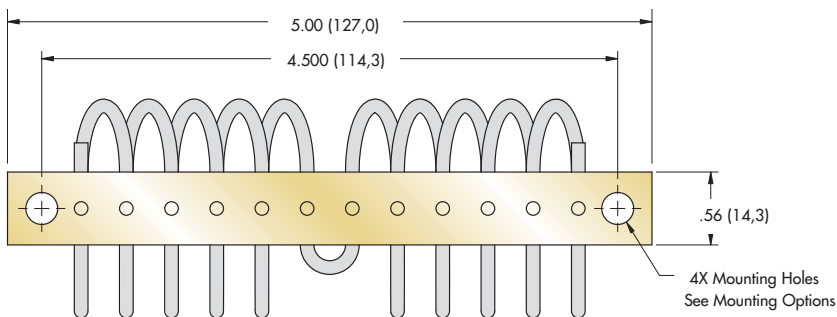

Note: Dimensions are in inches (mm)
Tolerances are ± .010 (± .25mm)

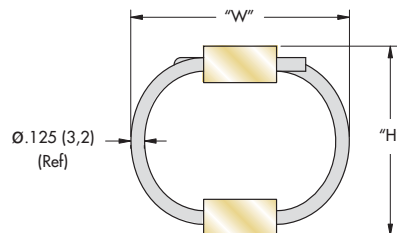
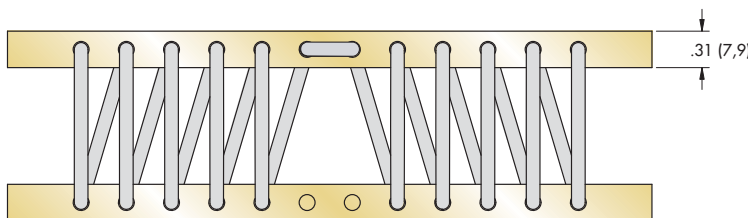

Size	Height "H" in. (mm)	Width (Ref) "W" in. (mm)	Unit Weight Lbs. (Kg)	Mounting Options	Thru Hole in. (mm)	Thread in. (mm)	C'sink Imperial (Metric)
WR4-100	1.10 (28)	1.40 (36)	0.26 (0,12)	B, D, E	Ø.272 ± .005 (Ø6,9 ± 0,13)	1/4-20 UNC (M6 X 1,0)	82° (90°)
WR4-200	1.20 (30)	1.50 (38)	0.26 (0,12)				
WR4-400	1.30 (33)	1.60 (41)	0.29 (0,13)				
WR4-500	1.40 (36)	1.70 (43)	0.29 (0,13)				
WR4-600	1.50 (38)	1.80 (46)	0.29 (0,13)				
WR4-700	1.60 (41)	1.90 (48)	0.30 (0,14)				
WR4-800	1.70 (43)	2.00 (51)	0.30 (0,14)	A, B, C, D, E, S			

Model Number Ordering Code

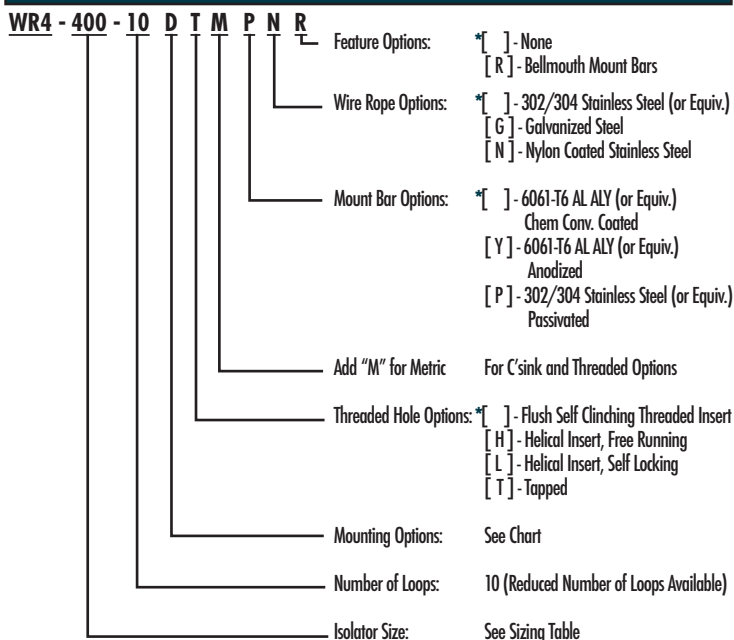

Mounting Options

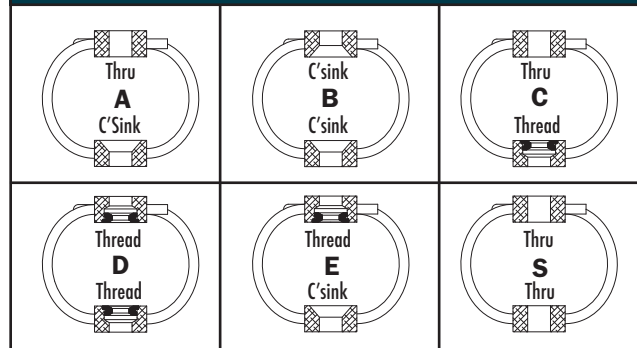

- Maximum recommended torque for standard threaded insert is 36 in.-lbs. (3,7 Nm)
- Operating Temperature Range: -150°F to 500°F (-100°C to 260°C)
- U.S. Patent 5,549,285

* Standard features. Any non-standard items may require longer lead times. Call for quotation.

Static Load vs. Deflection

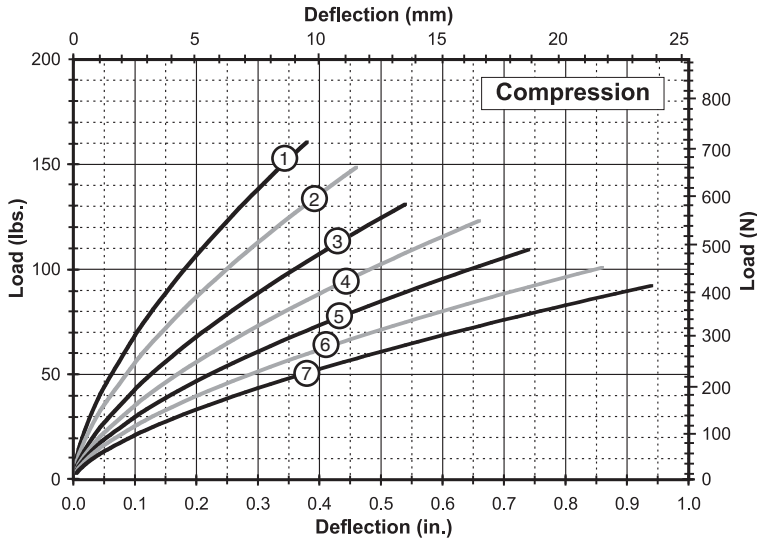

Compression

Curve	Model	Max Static Load Lbs. (N)	Max Deflection in. (mm)	Kv (vibration) Lbs./in. (kN/m)	Ks (shock) Lbs./in. (kN/m)
1	WR4-100-10	48 (213)	0.38 (9,7)	880 (154)	520 (91)
2	WR4-200-10	44 (194)	0.46 (11,7)	710 (124)	390 (68)
3	WR4-400-10	37 (166)	0.54 (13,7)	540 (95)	290 (51)
4	WR4-500-10	35 (156)	0.66 (16,8)	445 (78)	220 (39)
5	WR4-600-10	32 (142)	0.74 (18,8)	380 (67)	180 (32)
6	WR4-700-10	30 (133)	0.86 (21,8)	325 (57)	140 (25)
7	WR4-800-10	26 (117)	0.94 (23,9)	265 (46)	120 (21)

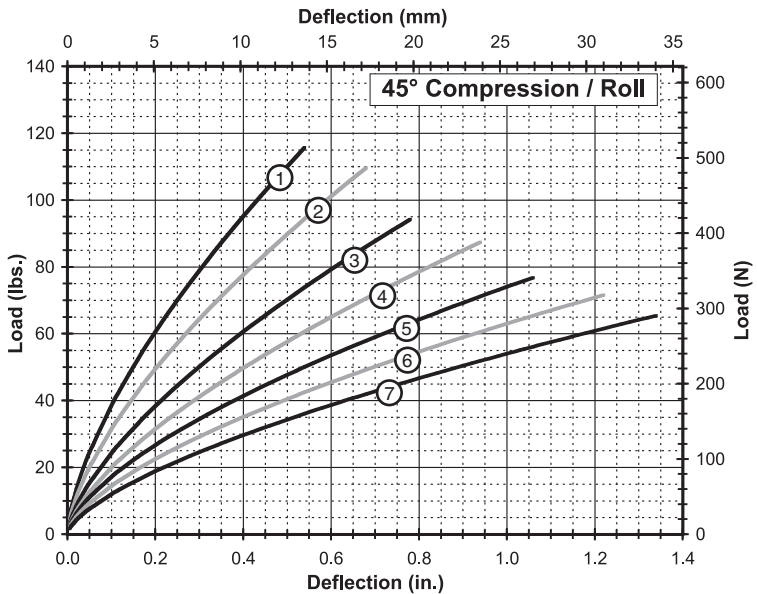

45° Compression / Roll

Curve	Model	Max Static Load Lbs. (N)	Max Deflection in. (mm)	Kv (vibration) Lbs./in. (kN/m)	Ks (shock) Lbs./in. (kN/m)
1	WR4-100-10	33 (149)	0.54 (13,7)	490 (86)	260 (46)
2	WR4-200-10	31 (138)	0.68 (17,3)	400 (70)	200 (35)
3	WR4-400-10	27 (118)	0.78 (19,8)	305 (53)	145 (25)
4	WR4-500-10	25 (111)	0.94 (23,9)	250 (44)	115 (20)
5	WR4-600-10	23 (102)	1.06 (26,9)	220 (39)	90 (16)
6	WR4-700-10	21 (94)	1.22 (31,0)	185 (32)	70 (12)
7	WR4-800-10	19 (84)	1.34 (34,0)	150 (26)	60 (11)

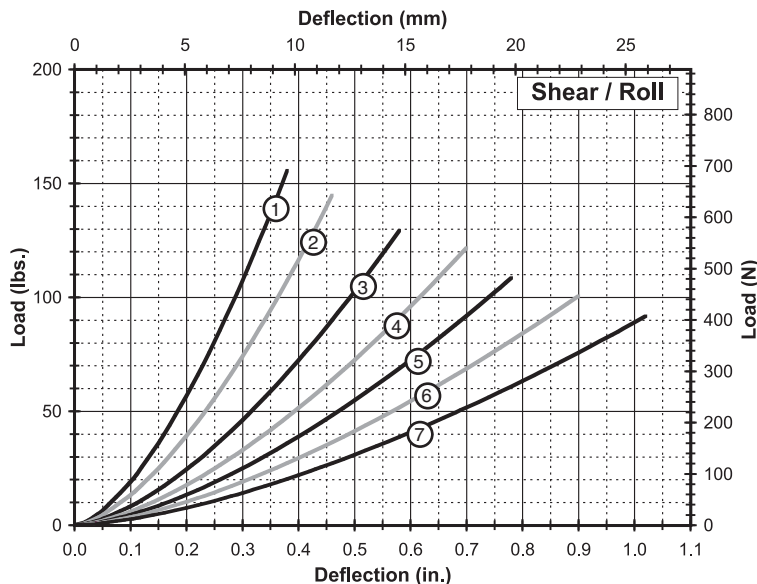

Shear / Roll

Curve	Model	Max Static Load Lbs. (N)	Max Deflection in. (mm)	Kv (vibration) Lbs./in. (kN/m)	Ks (shock) Lbs./in. (kN/m)
1	WR4-100-10	25 (111)	0.38 (9,7)	320 (56)	320 (56)
2	WR4-200-10	22 (98)	0.46 (11,7)	245 (43)	245 (43)
3	WR4-400-10	21 (93)	0.58 (14,7)	175 (31)	175 (31)
4	WR4-500-10	19 (85)	0.70 (17,8)	140 (25)	140 (25)
5	WR4-600-10	18 (80)	0.78 (19,8)	110 (19)	110 (19)
6	WR4-700-10	16 (71)	0.90 (22,9)	90 (16)	90 (16)
7	WR4-800-10	14 (62)	1.02 (25,9)	70 (12)	70 (12)

Note: Performance provided for full loop models with standard (302/304) stainless steel cable. Consult ENIDINE for other options. Do not extrapolate curves.

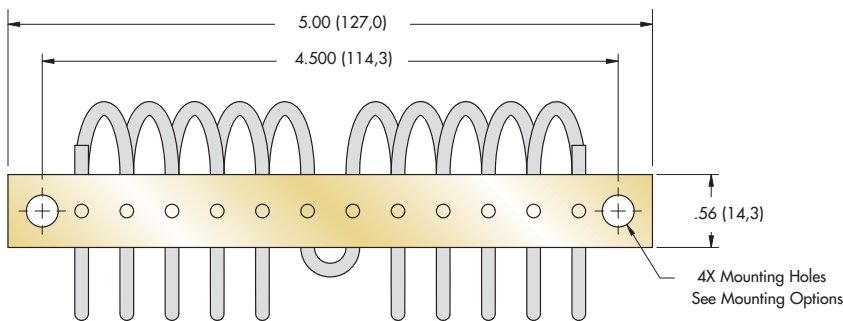

Note: Dimensions are in inches (mm)
Tolerances are ± .010 (± .25mm)

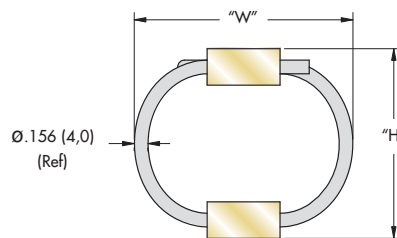
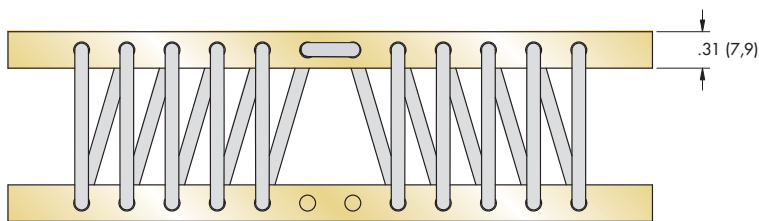

Size	Height "H" in. (mm)	Width (Ref) "W" in. (mm)	Unit Weight Lbs. (Kg)	Mounting Options	Thru Hole in. (mm)	Thread in. (mm)	C'sink Imperial (Metric)
WR5-200	1.20 (30)	1.60 (41)	0.33 (0,15)	B, D, E	Ø.272 ± .005 (Ø6,9 ± 0,13)	1/4-20 UNC (M6 X 1,0)	82° (90°)
WR5-400	1.30 (33)	1.70 (43)	0.33 (0,15)	A, B, C, D, E, S			
WR5-600	1.50 (38)	1.90 (48)	0.35 (0,16)				
WR5-800	1.80 (46)	2.10 (53)	0.38 (0,17)				
WR5-900	2.10 (53)	2.50 (64)	0.39 (0,18)				

Model Number Ordering Code

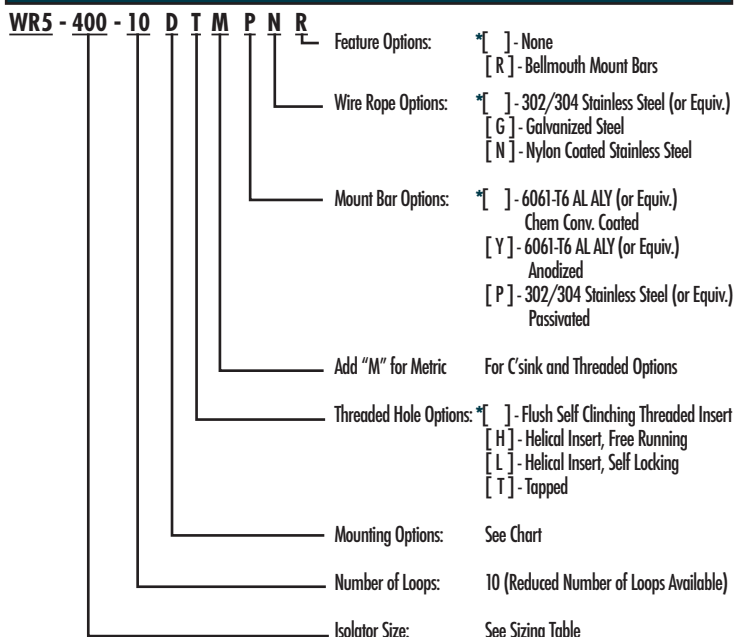

Mounting Options

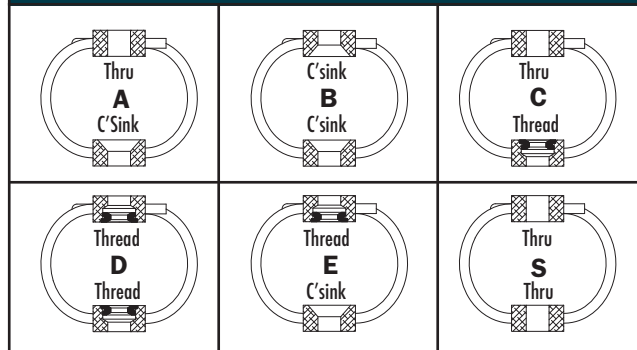

- Maximum recommended torque for standard threaded insert is 38 in.-lbs. (4,3 Nm)
- Operating Temperature Range: -150°F to 500°F (-100°C to 260°C)
- U.S. Patent 5,549,285

* Standard features. Any non-standard items may require longer lead times. Call for quotation.

Static Load vs. Deflection

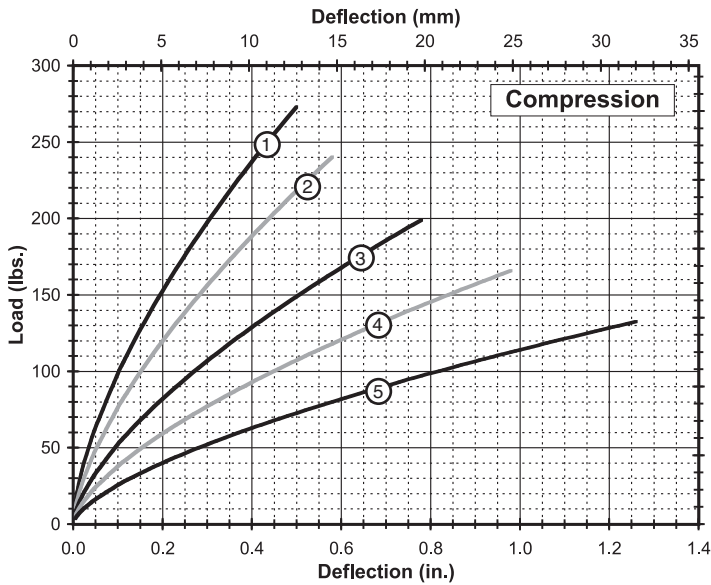

Compression

Curve	Model	Max Static Load Lbs. (N)	Max Deflection in. (mm)	Kv (vibration) Lbs./in. (kN/m)	Ks (shock) Lbs./in. (kN/m)
1	WR5-200-10	82 (364)	0.50 (12,7)	1,270 (222)	670 (117)
2	WR5-400-10	69 (309)	0.58 (14,7)	970 (170)	500 (88)
3	WR5-600-10	58 (257)	0.78 (19,8)	660 (116)	310 (54)
4	WR5-800-10	48 (216)	0.98 (24,9)	480 (84)	210 (37)
5	WR5-900-10	39 (172)	1.26 (32,0)	330 (58)	130 (23)

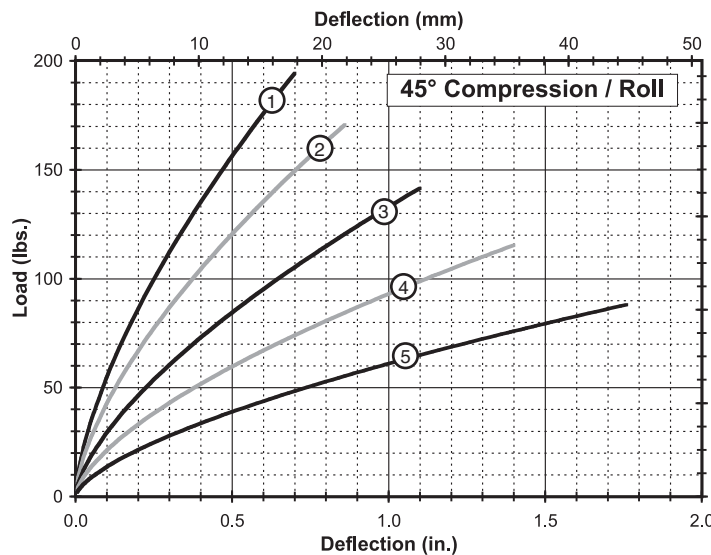

45° Compression/Roll

Curve	Model	Max Static Load Lbs. (N)	Max Deflection in. (mm)	Kv (vibration) Lbs./in. (kN/m)	Ks (shock) Lbs./in. (kN/m)
1	WR5-200-10	57 (254)	0.70 (17,8)	700 (123)	340 (60)
2	WR5-400-10	49 (218)	0.86 (21,8)	550 (96)	240 (42)
3	WR5-600-10	41 (182)	1.10 (27,9)	375 (66)	160 (28)
4	WR5-800-10	34 (151)	1.40 (35,6)	275 (48)	100 (18)
5	WR5-900-10	26 (115)	1.76 (44,7)	175 (31)	60 (11)

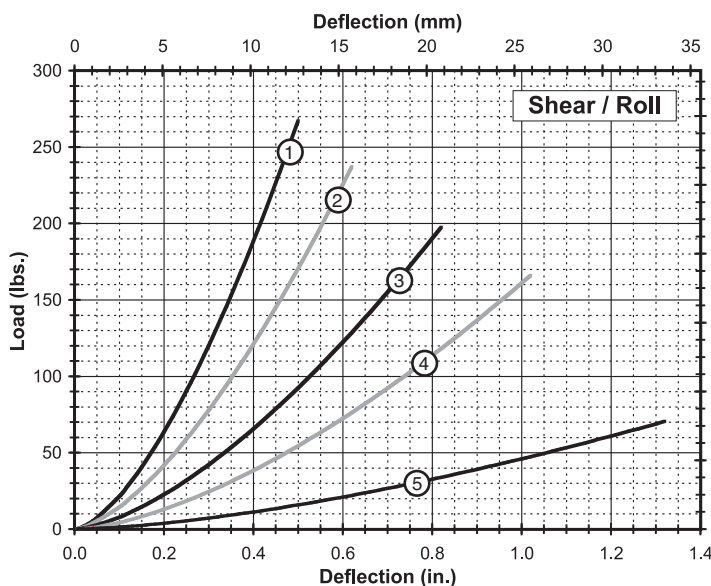

Shear/Roll

Curve	Model	Max Static Load Lbs. (N)	Max Deflection in. (mm)	Kv (vibration) Lbs./in. (kN/m)	Ks (shock) Lbs./in. (kN/m)
1	WR5-200-10	40 (178)	0.50 (12,7)	415 (73)	415 (73)
2	WR5-400-10	35 (156)	0.62 (15,7)	300 (53)	300 (53)
3	WR5-600-10	30 (133)	0.82 (20,8)	190 (33)	190 (33)
4	WR5-800-10	25 (111)	1.02 (25,9)	130 (23)	130 (23)
5	WR5-900-10	9 (40)	1.32 (33,5)	45 (7,9)	45 (7,9)

Note: Performance provided for full loop models with standard (302/304) stainless steel cable. Consult ENIDINE for other options. Do not extrapolate curves.

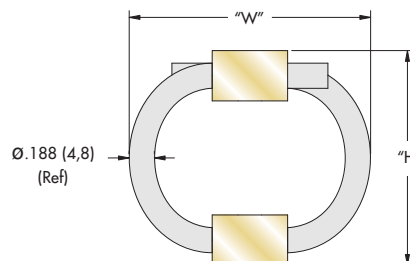
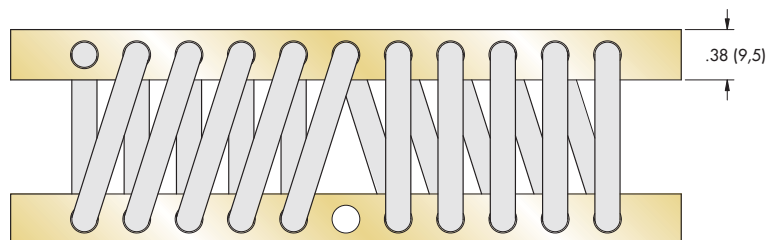
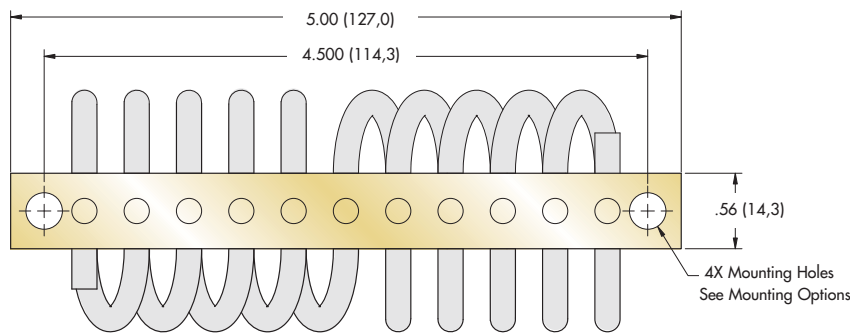

Size	Height "H" in. (mm)	Width (Ref) "W" in. (mm)	Unit Weight Lbs. (Kg)	Mounting Options	Thru Hole in. (mm)	Thread in. (mm)	C'sink Imperial (Metric)
WR6-200	1.20 (30)	1.40 (36)	0.42 (0,19)	D	Ø.272 ± .005 (Ø6,9 ± 0,13)	1/4-20 UNC (M6 X 1,0)	82° (90°)
WR6-300	1.30 (33)	1.50 (38)	0.43 (0,20)	B, D, E			
WR6-400	1.40 (36)	1.60 (41)	0.46 (0,21)				
WR6-500	1.50 (38)	1.70 (43)	0.47 (0,21)	A, B, C, D, E, S			
WR6-600	1.60 (41)	1.80 (46)	0.49 (0,22)				
WR6-700	1.70 (43)	1.90 (48)	0.54 (0,25)				
WR6-800	2.00 (51)	2.30 (58)	0.57 (0,26)				
WR6-850	2.13 (54)	2.94 (75)	0.59 (0,27)				
WR6-900	2.45 (62)	3.45 (88)	0.61 (0,28)	± .13 (± 3,30)			
WR6-950	3.20 (81)	4.20 (107)	0.63 (0,29)				

Model Number Ordering Code

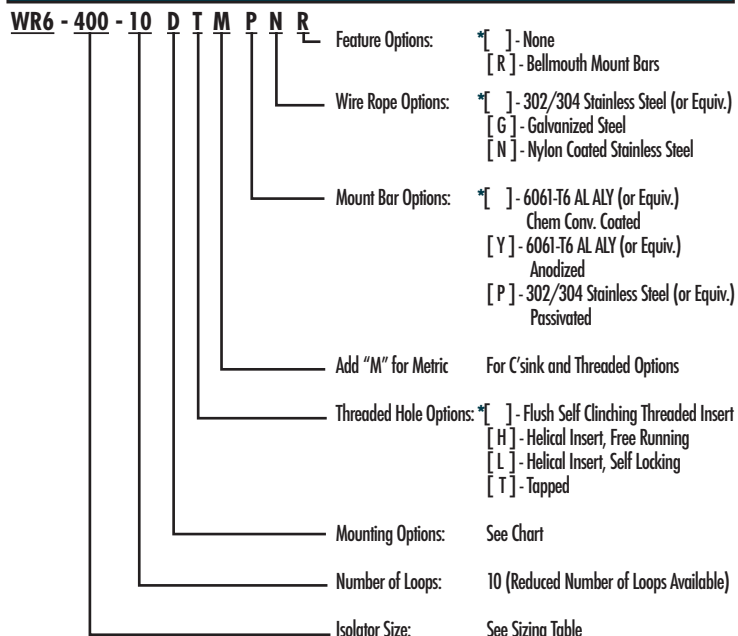

Mounting Options

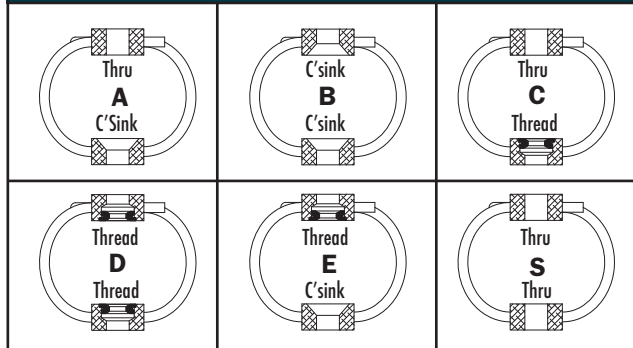

- Maximum recommended torque for standard threaded insert is 38 in.-lbs. (4,3 Nm)
- Operating Temperature Range: -150°F to 500°F (-100°C to 260°C)
- U.S. Patent 5,549,285

* Standard features. Any non-standard items may require longer lead times. Call for quotation.

Static Load vs. Deflection

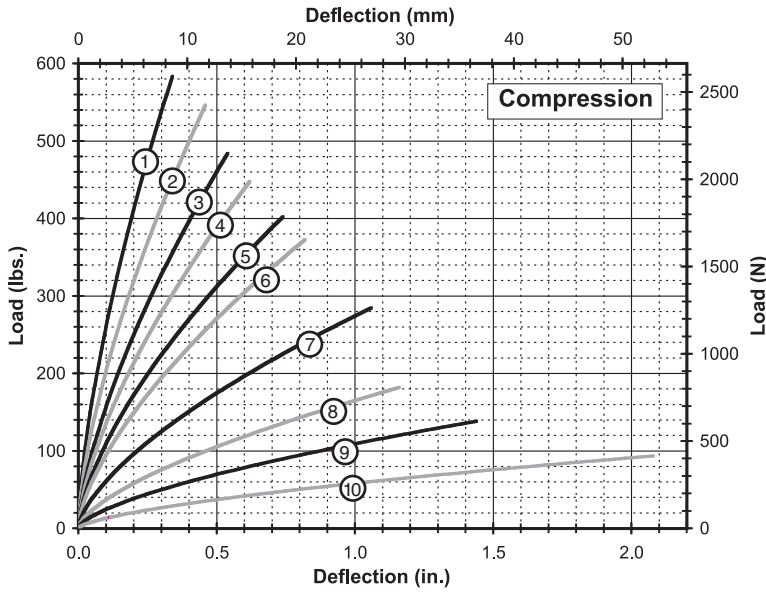

Compression

Curve	Model	Max Static Load Lbs. (N)	Max Deflection in. (mm)	Kv (vibration) Lbs./in. (kN/m)	Ks (shock) Lbs./in. (kN/m)
1	WR6-200-10	165 (734)	0.34 (8,6)	3,300 (578)	2,070 (363)
2	WR6-300-10	160 (712)	0.46 (11,7)	2,600 (455)	1,440 (252)
3	WR6-400-10	135 (601)	0.54 (13,7)	1,980 (347)	1,080 (189)
4	WR6-500-10	130 (578)	0.62 (15,7)	1,720 (301)	870 (152)
5	WR6-600-10	115 (512)	0.74 (18,8)	1,395 (244)	670 (117)
6	WR6-700-10	110 (489)	0.82 (20,8)	1,210 (212)	550 (96)
7	WR6-800-10	82 (365)	1.06 (26,9)	775 (136)	330 (58)
8	WR6-850-10	53 (236)	1.16 (29,5)	470 (82)	190 (33)
9	WR6-900-10	40 (178)	1.44 (36,6)	310 (54)	120 (21)
10	WR6-950-10	27 (120)	2.08 (52,8)	165 (29)	55 (10)

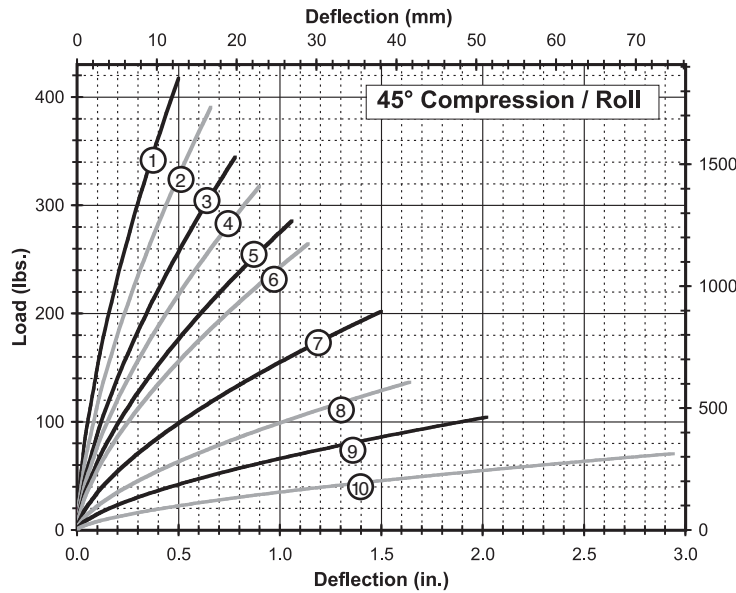

45° Compression/Roll

Curve	Model	Max Static Load Lbs. (N)	Max Deflection in. (mm)	Kv (vibration) Lbs./in. (kN/m)	Ks (shock) Lbs./in. (kN/m)
1	WR6-200-10	120 (534)	0.50 (12,7)	1,945 (341)	1,020 (179)
2	WR6-300-10	115 (512)	0.66 (16,8)	1,475 (258)	720 (126)
3	WR6-400-10	97 (432)	0.78 (19,8)	1,125 (197)	530 (93)
4	WR6-500-10	92 (409)	0.90 (22,9)	985 (172)	430 (75)
5	WR6-600-10	84 (373)	1.06 (26,9)	805 (141)	330 (58)
6	WR6-700-10	79 (350)	1.14 (29,0)	705 (123)	280 (49)
7	WR6-800-10	58 (260)	1.50 (38,1)	440 (77)	160 (28)
8	WR6-850-10	40 (177)	1.64 (41,7)	280 (49)	100 (18)
9	WR6-900-10	31 (136)	2.02 (51,3)	190 (33)	65 (11)
10	WR6-950-10	21 (91)	2.94 (74,7)	100 (18)	30 (5,3)

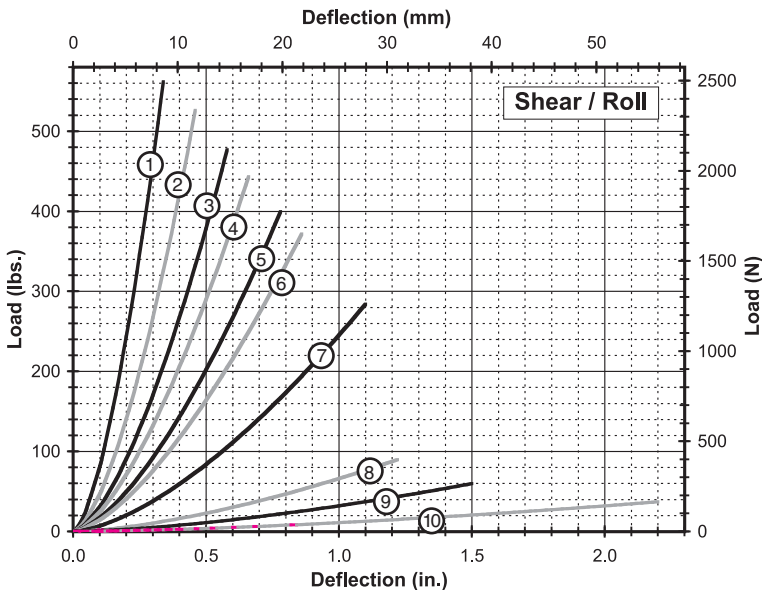

Shear/Roll

Curve	Model	Max Static Load Lbs. (N)	Max Deflection in. (mm)	Kv (vibration) Lbs./in. (kN/m)	Ks (shock) Lbs./in. (kN/m)
1	WR6-200-10	80 (356)	0.34 (8,6)	1,280 (224)	1,280 (224)
2	WR6-300-10	80 (356)	0.46 (11,7)	890 (156)	890 (156)
3	WR6-400-10	75 (334)	0.58 (14,7)	640 (112)	640 (112)
4	WR6-500-10	70 (311)	0.66 (16,8)	530 (93)	530 (93)
5	WR6-600-10	65 (289)	0.78 (19,8)	400 (70)	400 (70)
6	WR6-700-10	60 (267)	0.86 (21,8)	340 (60)	340 (60)
7	WR6-800-10	45 (200)	1.10 (27,9)	200 (35)	200 (35)
8	WR6-850-10	13 (58)	1.22 (31,0)	60 (11)	60 (11)
9	WR6-900-10	9 (40)	1.50 (38,1)	30 (5,3)	30 (5,3)
10	WR6-950-10	5 (22)	2.20 (55,9)	13 (2,3)	13 (2,3)

Note: Performance provided for full loop models with standard (302/304) stainless steel cable. Consult ENIDINE for other options. Do not extrapolate curves.

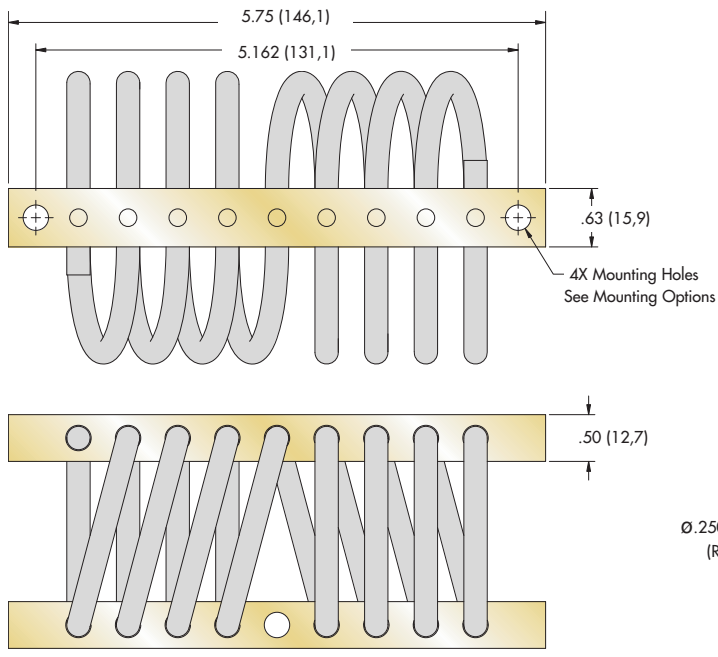

Note: Dimensions are in inches (mm)
Tolerances are ± .010 (± .25mm)

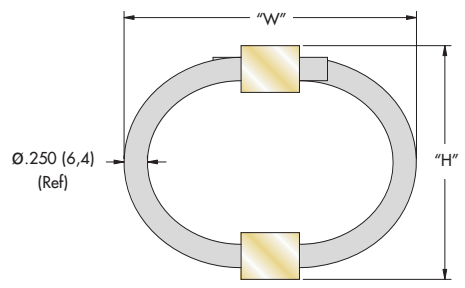

Size	Height "H" in. (mm)	Width (Ref) "W" in. (mm)	Unit Weight Lbs. (Kg)	Mounting Options	Thru Hole in. (mm)	Thread in. (mm)	C'sink Imperial (Metric)
WR8-200	1.90 (48)	2.20 (56)	0.84 (0,38)	A, B, C, D, E, S	Ø.272 ± .005 (Ø6,9 ± 0,13)	1/4-28 UNF (M6 X 1,0)	82° (90°)
WR8-400	2.13 (54)	2.50 (64)	0.90 (0,41)				
WR8-500	2.31 (59)	2.80 (71)	0.94 (0,43)				
WR8-600	2.50 (64)	3.13 (80)	1.04 (0,47)				
WR8-700	2.50 (64)	3.50 (89)	1.14 (0,52)				
WR8-800	2.63 (67)	3.75 (95)	1.20 (0,54)				
WR8-850	2.63 (67)	3.95 (100)	1.25 (0,57)				
WR8-900	3.25 (83)	4.25 (108)	1.30 (0,59)				

Model Number Ordering Code

WR8 - 400 - 8 D T M P N R

- WR8** - Feature Options:
 - [] - None
 - [R] - Bellmouth Mount Bars
- 400** - Wire Rope Options:
 - [] - 302/304 Stainless Steel (or Equiv.)
 - [G] - Galvanized Steel
 - [N] - Nylon Coated Stainless Steel
- 8** - Mount Bar Options:
 - [] - 6061-T6 AL ALY (or Equiv.) Chem Conv. Coated
 - [Y] - 6061-T6 AL ALY (or Equiv.) Anodized
 - [P] - 302/304 Stainless Steel (or Equiv.) Passivated
- D** - Add "M" for Metric For C'sink and Threaded Options
- T** - Threaded Hole Options:
 - [] - Flush Self Clinching Threaded Insert
 - [H] - Helical Insert, Free Running
 - [L] - Helical Insert, Self Locking
 - [T] - Tapped
- M** - Mounting Options: See Chart
- P** - Number of Loops: 08 (Reduced Number of Loops Available)
- N** - Isolator Size: See Sizing Table
- R** - Feature Options:
 - [] - None
 - [R] - Bellmouth Mount Bars

Mounting Options

- Maximum recommended torque for standard threaded insert is 38 in.-lbs. (4,3 Nm)
- Operating Temperature Range: -150°F to 500°F (-100°C to 260°C)
- U.S. Patent 5,549,285

* Standard features. Any non-standard items may require longer lead times. Call for quotation.

Static Load vs. Deflection

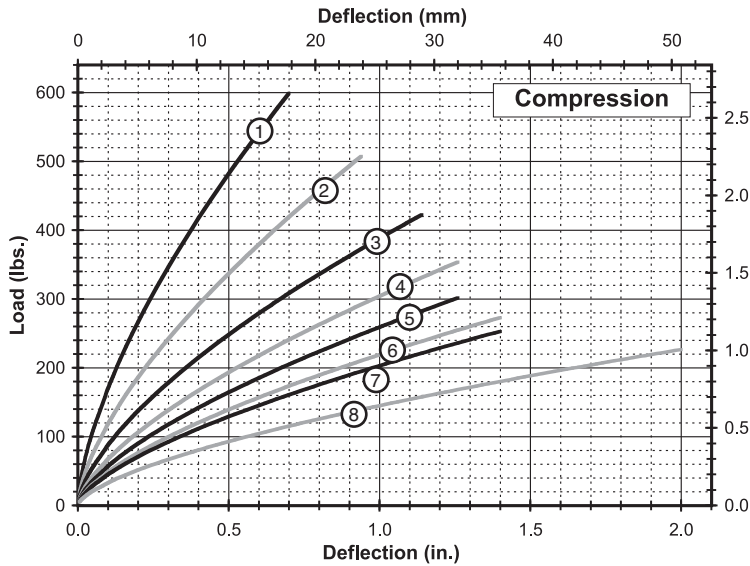

Compression

Curve	Model	Max Static Load Lbs. (N)	Max Deflection in. (mm)	Kv (vibration) Lbs./in. (kN/m)	Ks (shock) Lbs./in. (kN/m)
1	WR8-200-08	175 (778)	0.70 (17,8)	2,180 (382)	1,040 (182)
2	WR8-400-08	150 (667)	0.94 (23,9)	1,520 (266)	660 (116)
3	WR8-500-08	125 (556)	1.14 (29,0)	1,120 (196)	450 (79)
4	WR8-600-08	100 (445)	1.26 (32,0)	860 (151)	340 (60)
5	WR8-700-08	87 (386)	1.26 (32,0)	725 (127)	290 (51)
6	WR8-800-08	79 (351)	1.40 (35,6)	620 (109)	240 (42)
7	WR8-850-08	73 (325)	1.40 (35,6)	570 (100)	220 (39)
8	WR8-900-08	67 (297)	2.00 (50,8)	420 (74)	140 (25)

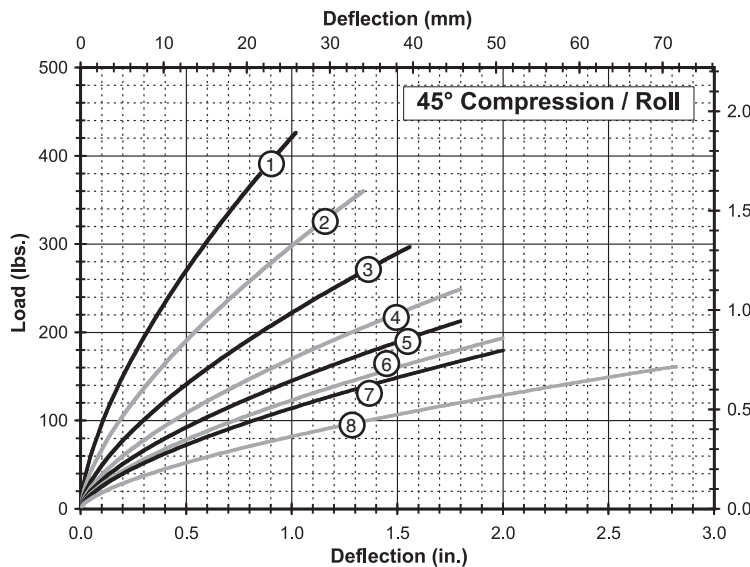

45° Compression/Roll

Curve	Model	Max Static Load Lbs. (N)	Max Deflection in. (mm)	Kv (vibration) Lbs./in. (kN/m)	Ks (shock) Lbs./in. (kN/m)
1	WR8-200-08	125 (556)	1.02 (25,9)	1,230 (215)	510 (89)
2	WR8-400-08	105 (467)	1.34 (34,0)	860 (151)	330 (58)
3	WR8-500-08	88 (390)	1.56 (39,6)	625 (109)	230 (40)
4	WR8-600-08	72 (321)	1.80 (45,7)	490 (86)	170 (30)
5	WR8-700-08	61 (273)	1.80 (45,7)	410 (72)	140 (25)
6	WR8-800-08	56 (248)	2.00 (50,8)	350 (61)	120 (21)
7	WR8-850-08	51 (229)	2.00 (50,8)	320 (56)	110 (19)
8	WR8-900-08	47 (209)	2.82 (71,6)	235 (41)	70 (12)

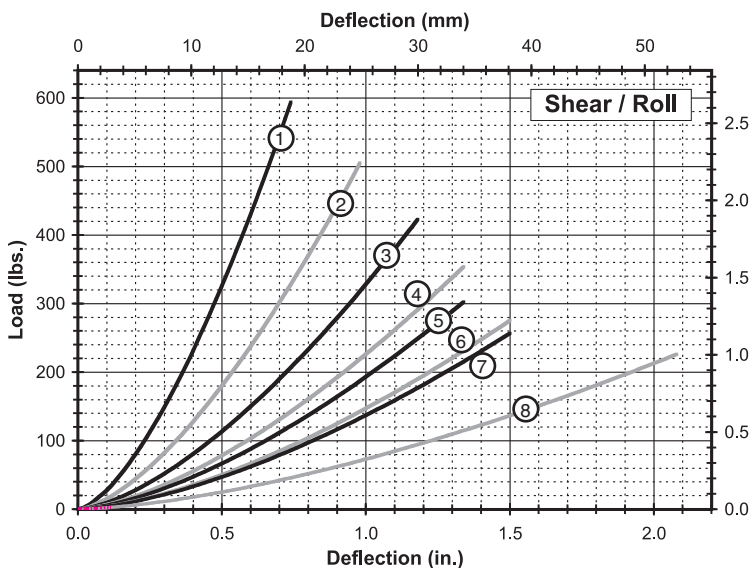

Shear/Roll

Curve	Model	Max Static Load Lbs. (N)	Max Deflection in. (mm)	Kv (vibration) Lbs./in. (kN/m)	Ks (shock) Lbs./in. (kN/m)
1	WR8-200-08	95 (423)	0.74 (18,8)	630 (110)	630 (110)
2	WR8-400-08	80 (356)	0.98 (24,9)	410 (72)	410 (72)
3	WR8-500-08	70 (311)	1.18 (30,0)	280 (49)	280 (49)
4	WR8-600-08	55 (245)	1.34 (34,0)	210 (37)	210 (37)
5	WR8-700-08	50 (222)	1.34 (34,0)	180 (32)	180 (32)
6	WR8-800-08	45 (200)	1.50 (38,1)	140 (25)	140 (25)
7	WR8-850-08	40 (178)	1.50 (38,1)	130 (23)	130 (23)
8	WR8-900-08	35 (156)	2.08 (52,8)	90 (16)	90 (16)

Note: Performance provided for full loop models with standard (302/304) stainless steel cable. Consult ENIDINE for other options. Do not extrapolate curves.

Technical Data

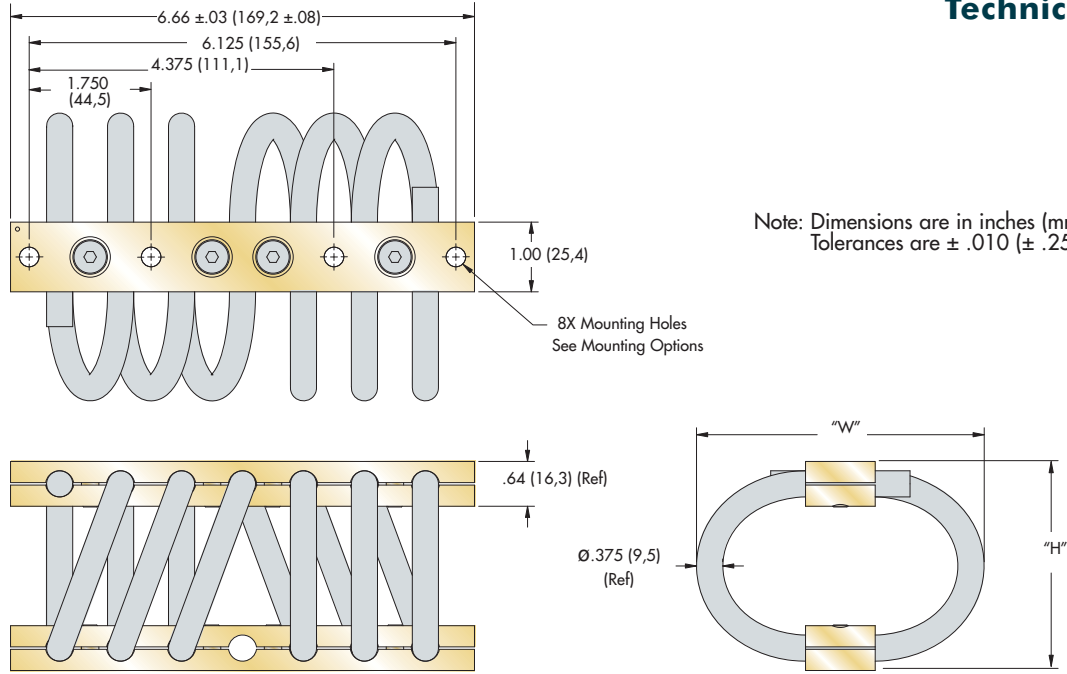

Size	Height "H" in. (mm)	Width (Ref) "W" in. (mm)	Unit Weight Lbs. (Kg)	Mounting Options	Thru Hole in. (mm)	Thread in. (mm)	C'sink Imperial (Metric)
WR12-206	2.80 (71)	3.31 (84)	1.82 (0,83)	A, B, C, D, E, S	0.281 ^{+.005} _{-.015} (Ø7,4 ^{+.013} _{-.038})	1/4-28 UNF (M6 X 1,0)	82° (90°)
WR12-306	2.90 (74)	3.50 (89)	1.88 (0,85)				
WR12-406	3.00 (76)	4.13 (105)	1.99 (0,90)				
WR12-506	3.25 (83)	4.25 (108)	2.09 (0,95)				
WR12-606	3.50 (89)	4.25 (108)	2.15 (0,98)				
WR12-706	4.13 (105)	4.75 (121)	2.36 (1,07)				
WR12-806	4.25 (108)	5.50 (140)	2.48 (1,12)				

Model Number Ordering Code

WR12 - 406 - 6 D H M P N R

Feature Options: * [] - None
[R] - Bellmouth Mount Bars

Wire Rope Options: * [] - 302/304 Stainless Steel (or Equiv.)
[G] - Galvanized Steel
[N] - Nylon Coated Stainless Steel

Mount Bar Options: * [] - 6061-T6 AL ALY (or Equiv.)
Chem Conv. Coated
[Y] - 6061-T6 AL ALY (or Equiv.)
Anodized
[P] - 302/304 Stainless Steel (or Equiv.)
Passivated

Add "M" for Metric For C'sink and Threaded Options

Threaded Hole Options: * [] - Tapped
[H] - Helical Insert, Free Running
[L] - Helical Insert, Self Locking

Mounting Options: See Chart

Number of Loops: 06 (Reduced Number of Loops Available)

Isolator Size: See Sizing Table

Mounting Options

- Maximum recommended torque for threaded bar 100 in.-lbs. (10 Nm)
- Operating Temperature Range: -150°F to 500°F (-100°C to 260°C)

* Standard features. Any non-standard items may require longer lead times. Call for quotation.

Static Load vs. Deflection

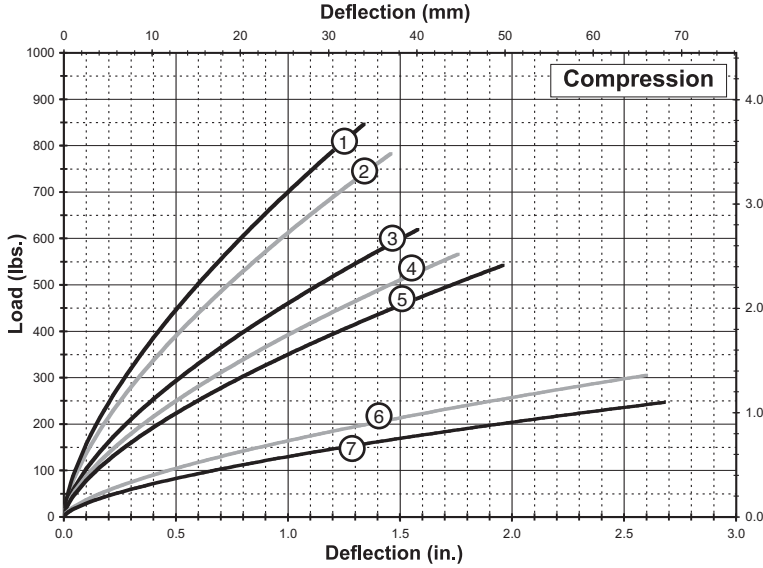

Compression

Curve	Model	Max Static Load Lbs. (N)	Max Deflection in. (mm)	Kv (vibration) Lbs./in. (kN/m)	Ks (shock) Lbs./in. (kN/m)
1	WR12-206-06	245 (1 090)	1.34 (34,0)	1,570 (275)	770 (135)
2	WR12-306-06	230 (1 023)	1.46 (37,1)	1,370 (240)	650 (114)
3	WR12-406-06	180 (801)	1.58 (40,1)	1,030 (180)	480 (84)
4	WR12-506-06	165 (734)	1.76 (44,7)	880 (154)	390 (68)
5	WR12-606-06	160 (712)	1.96 (49,8)	785 (137)	340 (60)
6	WR12-706-06	89 (396)	2.60 (66,0)	370 (65)	140 (25)
7	WR12-806-06	72 (320)	2.68 (68,1)	290 (51)	110 (19)

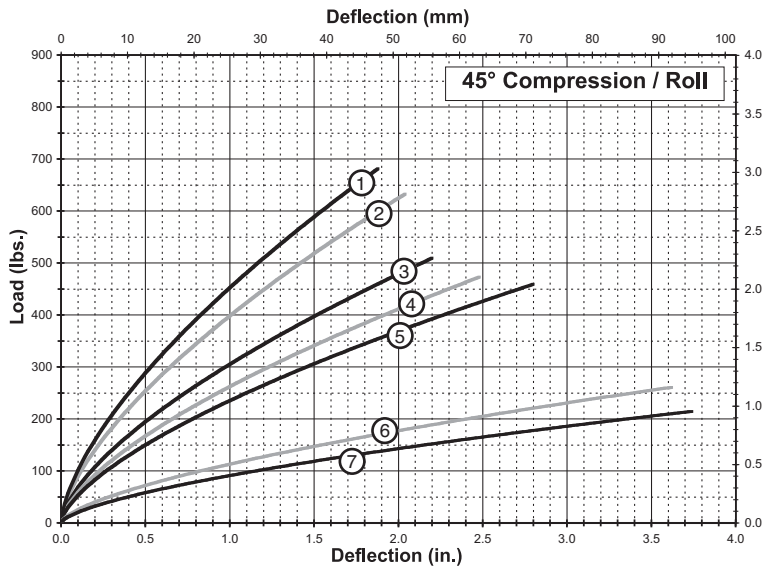

45° Compression/Roll

Curve	Model	Max Static Load Lbs. (N)	Max Deflection in. (mm)	Kv (vibration) Lbs./in. (kN/m)	Ks (shock) Lbs./in. (kN/m)
1	WR12-206-06	200 (890)	1.88 (47,8)	1,010 (177)	440 (77)
2	WR12-306-06	185 (823)	2.04 (51,8)	890 (156)	380 (67)
3	WR12-406-06	150 (667)	2.20 (55,9)	685 (120)	280 (49)
4	WR12-506-06	140 (623)	2.48 (63,0)	590 (103)	230 (40)
5	WR12-606-06	135 (601)	2.80 (71,1)	525 (92)	200 (35)
6	WR12-706-06	77 (341)	3.62 (91,9)	250 (44)	90 (16)
7	WR12-806-06	63 (280)	3.74 (95,0)	205 (36)	70 (12)

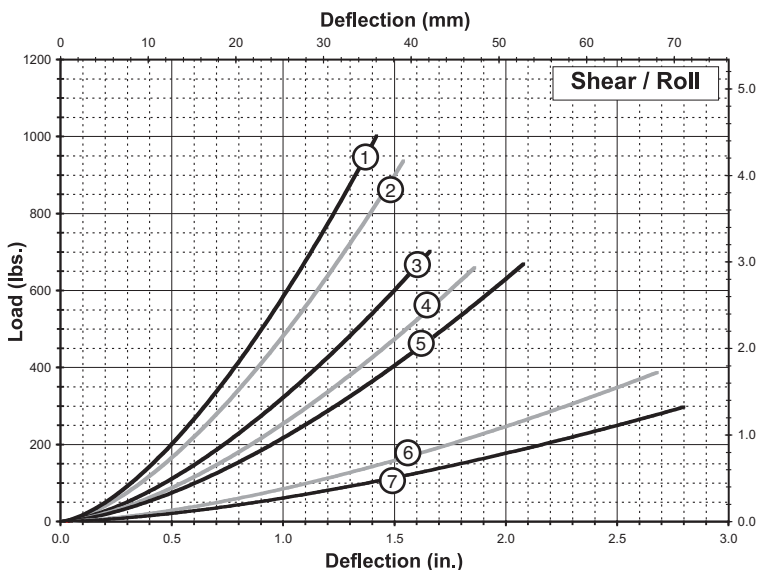

Shear/Roll

Curve	Model	Max Static Load Lbs. (N)	Max Deflection in. (mm)	Kv (vibration) Lbs./in. (kN/m)	Ks (shock) Lbs./in. (kN/m)
1	WR12-206-06	155 (689)	1.42 (36,1)	560 (98)	560 (98)
2	WR12-306-06	145 (645)	1.54 (39,1)	480 (84)	480 (84)
3	WR12-406-06	110 (489)	1.66 (42,2)	330 (58)	330 (58)
4	WR12-506-06	105 (467)	1.86 (47,2)	280 (49)	280 (49)
5	WR12-606-06	100 (445)	2.08 (52,8)	250 (44)	250 (44)
6	WR12-706-06	45 (200)	2.68 (68,1)	115 (20)	115 (20)
7	WR12-806-06	35 (156)	2.80 (71,1)	85 (15)	85 (15)

Note: Performance provided for full loop models with standard (302/304) stainless steel cable.
Consult ENIDINE for other options. Do not extrapolate curves.

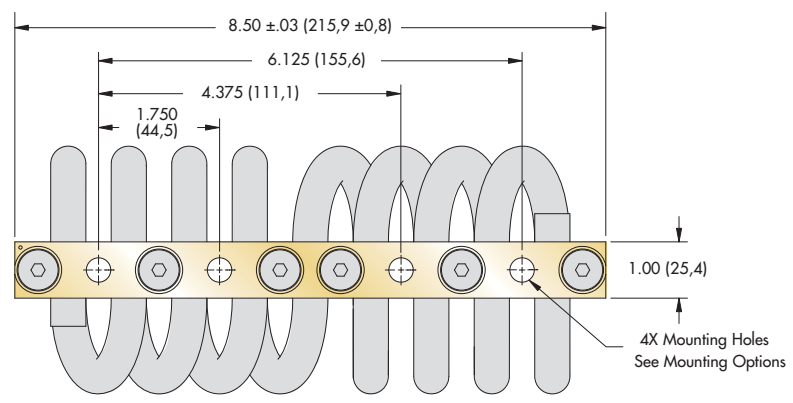

Note: Dimensions are in inches (mm)
Tolerances are ± .010 (± .25mm)

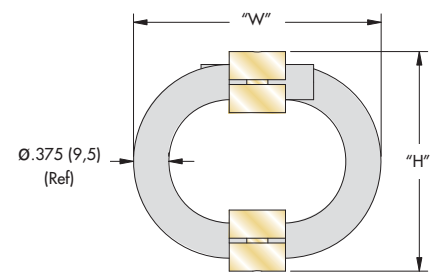
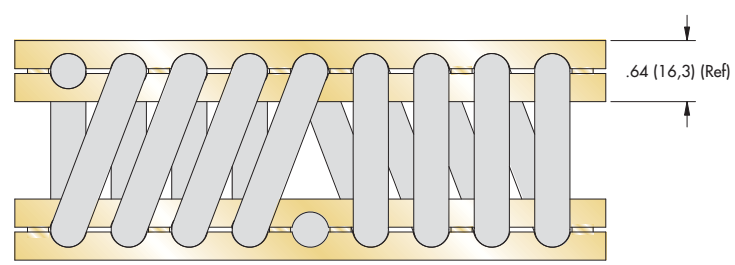

Size	Height "H" in. (mm)	Width (Ref) "W" in. (mm)	Unit Weight Lbs. (Kg)	Mounting Options	Thru Hole in. (mm)	Thread in. (mm)	C'sink Imperial (Metric)
WR12-200	2.80 (71)	3.31 (84)	2.43 (1,10)	A, B, C, D, E, S	Ø.281 + .005 - .015 (Ø9,0 + 0,13 - 0,38)	1/4-28 UNF *(M8 X 1,25)	82° (90°)
WR12-300	2.90 (74)	3.50 (89)	2.50 (1,13)				
WR12-400	3.00 (76)	4.13 (105)	2.65 (1,20)				
WR12-500	3.25 (83)	4.25 (108)	2.78 (1,26)				
WR12-600	3.50 (89)	4.25 (108)	2.87 (1,30)				
WR12-700	4.13 (105)	4.75 (121)	3.15 (1,43)				
WR12-800	4.25 (108)	5.50 (140)	3.31 (1,50)				

* Tapped M8 x 1.25, Inserts M6 x 1.0

Model Number Ordering Code

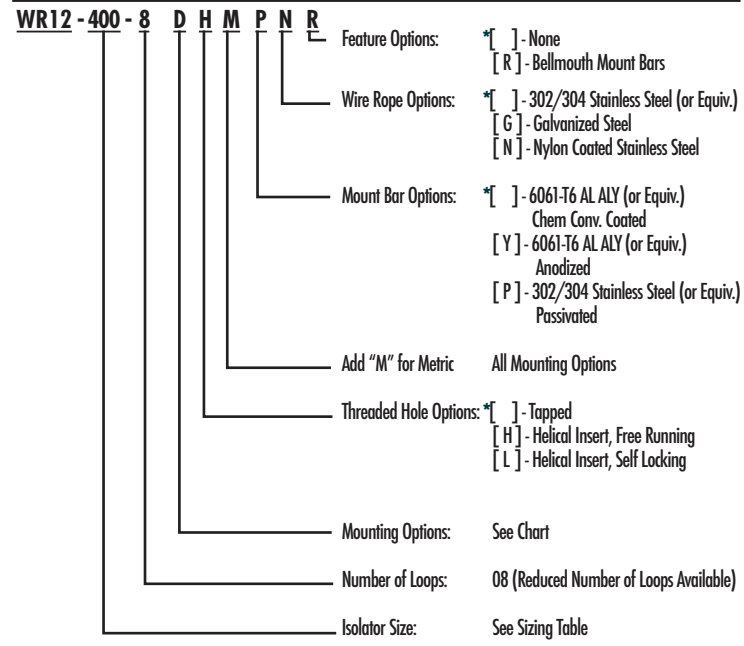

Mounting Options

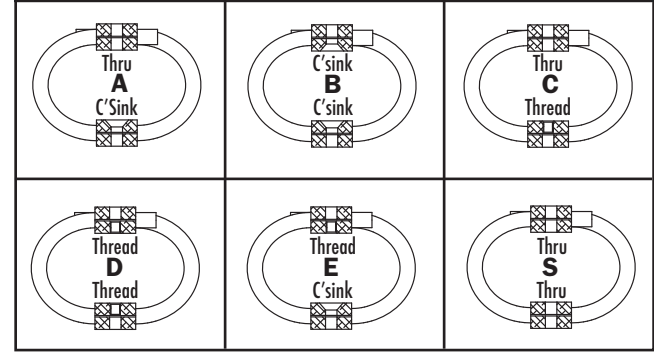

- Maximum recommended torque for threaded bar is 100 in.-lbs. (20 Nm)
- Operating Temperature Range: -150°F to 500°F (-100°C to 260°C)

* Standard features. Any non-standard items may require longer lead times. Call for quotation.

Static Load vs. Deflection

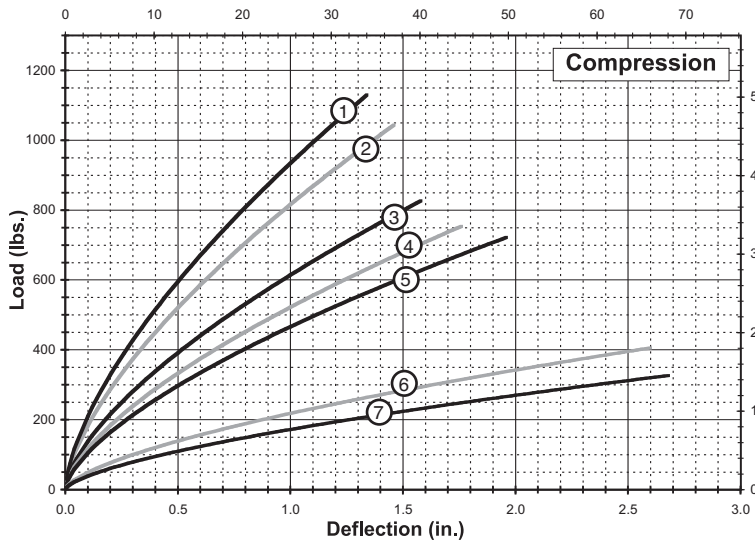

Compression

Curve	Model	Max Static Load Lbs. (N)	Max Deflection in. (mm)	Kv (vibration) Lbs./in. (kN/m)	Ks (shock) Lbs./in. (kN/m)
1	WR12-200-08	330 (1 468)	1.34 (34,0)	2,090 (366)	1,020 (179)
2	WR12-300-08	305 (1 357)	1.46 (37,1)	1,830 (320)	870 (152)
3	WR12-400-08	240 (1 068)	1.58 (40,1)	1,380 (242)	630 (110)
4	WR12-500-08	220 (979)	1.76 (44,7)	1,170 (205)	520 (91)
5	WR12-600-08	210 (934)	1.96 (49,8)	1,040 (182)	450 (79)
6	WR12-700-08	120 (534)	2.60 (66,0)	490 (86)	190 (33)
7	WR12-800-08	95 (423)	2.68 (68,1)	385 (67)	150 (26)

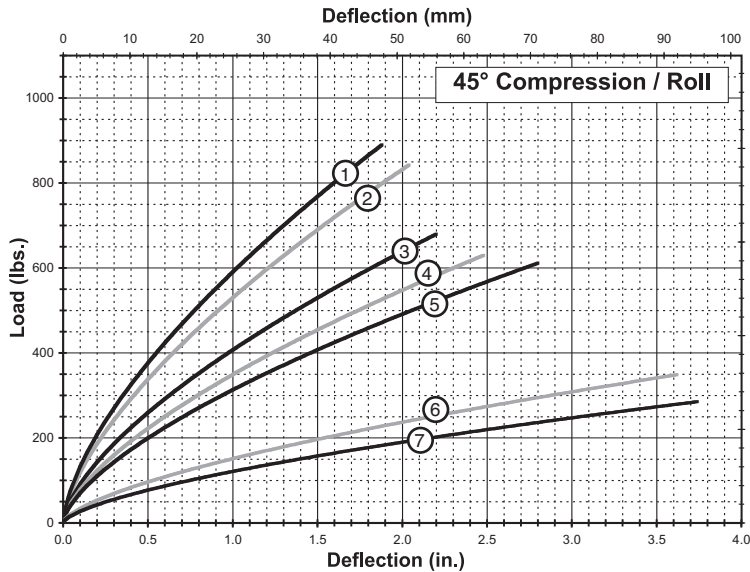

45° Compression/Roll

Curve	Model	Max Static Load Lbs. (N)	Max Deflection in. (mm)	Kv (vibration) Lbs./in. (kN/m)	Ks (shock) Lbs./in. (kN/m)
1	WR12-200-08	265 (1 179)	1.88 (47,8)	1,350 (236)	590 (103)
2	WR12-300-08	245 (1 090)	2.04 (51,8)	1,190 (208)	500 (88)
3	WR12-400-08	200 (890)	2.20 (55,9)	910 (159)	370 (65)
4	WR12-500-08	185 (823)	2.48 (63,0)	780 (137)	310 (54)
5	WR12-600-08	175 (778)	2.80 (71,1)	700 (123)	270 (47)
6	WR12-700-08	105 (467)	3.62 (91,9)	340 (60)	120 (21)
7	WR12-800-08	84 (373)	3.74 (95,0)	270 (47)	90 (16)

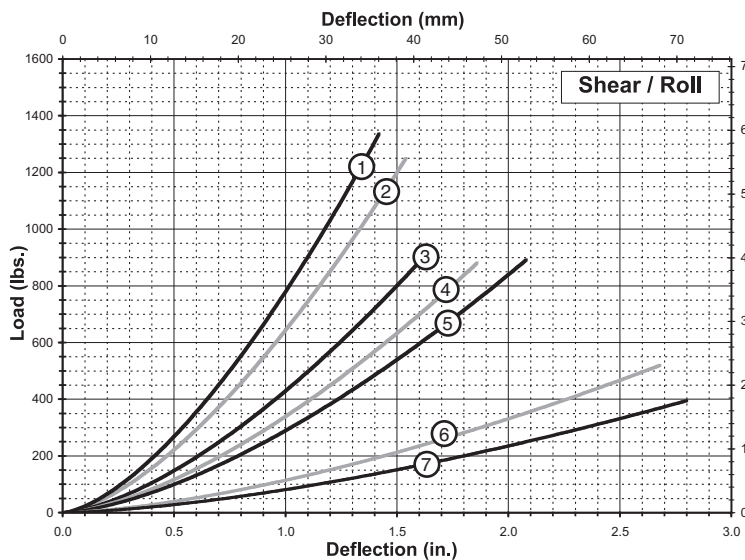

Shear/Roll

Curve	Model	Max Static Load Lbs. (N)	Max Deflection in. (mm)	Kv (vibration) Lbs./in. (kN/m)	Ks (shock) Lbs./in. (kN/m)
1	WR12-200-08	205 (912)	1.42 (36,1)	740 (130)	740 (130)
2	WR12-300-08	195 (867)	1.54 (39,1)	640 (112)	640 (112)
3	WR12-400-08	150 (667)	1.66 (42,2)	440 (77)	440 (77)
4	WR12-500-08	140 (623)	1.86 (47,2)	370 (65)	370 (65)
5	WR12-600-08	135 (601)	2.08 (52,8)	340 (60)	340 (60)
6	WR12-700-08	60 (267)	2.68 (68,1)	155 (27)	155 (27)
7	WR12-800-08	45 (200)	2.80 (71,1)	110 (19)	110 (19)

Note: Performance provided for full loop models with standard (302/304) stainless steel cable. Consult ENIDINE for other options. Do not extrapolate curves.

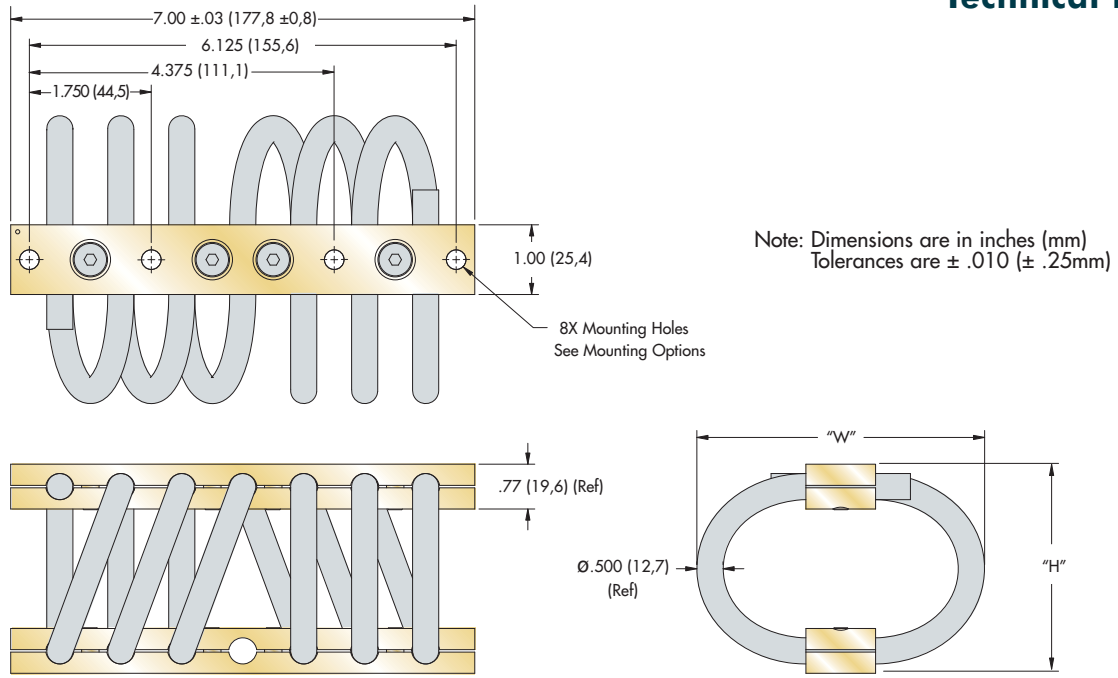

Size	Height "H" in. (mm)	Width (Ref) "W" in. (mm)	Unit Weight Lbs. (Kg)	Mounting Options	Thru Hole in. (mm)	Thread in. (mm)	C'sink Imperial (Metric)
WR16-206	3.00 (76)	3.63 (92)	3.00 (1,36)	A, B, C, D, E, S	Ø.354 ^{+0,005} _{-.015} (Ø9,0 ^{+0,13} _{-0,38})	1/4-28 UNF *(M8 X 1,25)	82° (90°)
WR16-306	3.25 (83)	4.00 (102)	3.15 (1,43)				
WR16-406	3.50 (89)	4.13 (105)	3.30 (1,50)				
WR16-606	3.75 (95)	4.75 (121)	3.68 (1,67)				
WR16-706	4.25 (108)	5.25 (133)	3.98 (1,81)				
WR16-806	4.90 (124)	5.65 (144)	4.46 (2,02)				
WR16-856	5.40 (137)	6.13 (156)	4.80 (2,18)				
WR16-906	6.10 (155)	7.10 (180)	5.10 (2,31)				

* Tapped M8 x 1.25, Inserts M7 x 1.0

Model Number Ordering Code

WR16-406-6 D H M P N R

- Feature Options:
 - * [] - None
 - [R] - Bellmouth Mount Bars
- Wire Rope Options:
 - * [] - 302/304 Stainless Steel (or Equiv.)
 - [G] - Galvanized Steel
 - [N] - Nylon Coated Stainless Steel
- Mount Bar Options:
 - * [] - 6061-T6 AL ALY (or Equiv.) Chem Conv. Coated
 - [Y] - 6061-T6 AL ALY (or Equiv.) Anodized
 - [P] - 302/304 Stainless Steel (or Equiv.) Passivated
- Add "M" for Metric For C'sink and Threaded Options
- Threaded Hole Options:
 - * [] - Tapped
 - [H] - Helical Insert, Free Running
 - [L] - Helical Insert, Self Locking
- Mounting Options: See Chart
- Number of Loops: 06 (Reduced Number of Loops Available)
- Isolator Size: See Sizing Table

Mounting Options

- Maximum recommended torque for threaded bar is 115 in.-lbs. (20 Nm)
- Operating Temperature Range: -150°F to 500°F (-100°C to 260°C)

* Standard features. Any non-standard items may require longer lead times. Call for quotation.

Static Load vs. Deflection

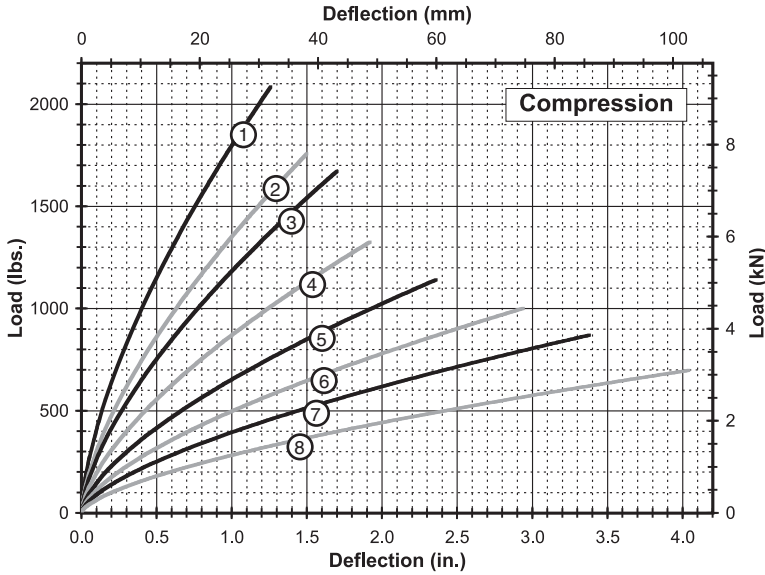

Compression

Curve	Model	Max Static Load lbs. (N)	Max Deflection in. (mm)	Kv (vibration) lbs./in. (kN/m)	Ks (shock) lbs./in. (kN/m)
1	WR16-206-06	615 (2 736)	1.26 (32,0)	4,090 (716)	2,010 (352)
2	WR16-306-06	515 (2 291)	1.50 (38,1)	3,030 (531)	1,420 (249)
3	WR16-406-06	485 (2 157)	1.70 (43,2)	2,630 (461)	1,190 (208)
4	WR16-606-06	390 (1 735)	1.92 (48,8)	1,960 (343)	840 (147)
5	WR16-706-06	330 (1 468)	2.36 (59,9)	1,460 (256)	590 (103)
6	WR16-806-06	290 (1 290)	2.94 (74,7)	1,120 (196)	410 (72)
7	WR16-856-06	255 (1 134)	3.38 (85,9)	880 (154)	310 (54)
8	WR16-906-06	205 (912)	4.04 (102,6)	635 (111)	210 (37)

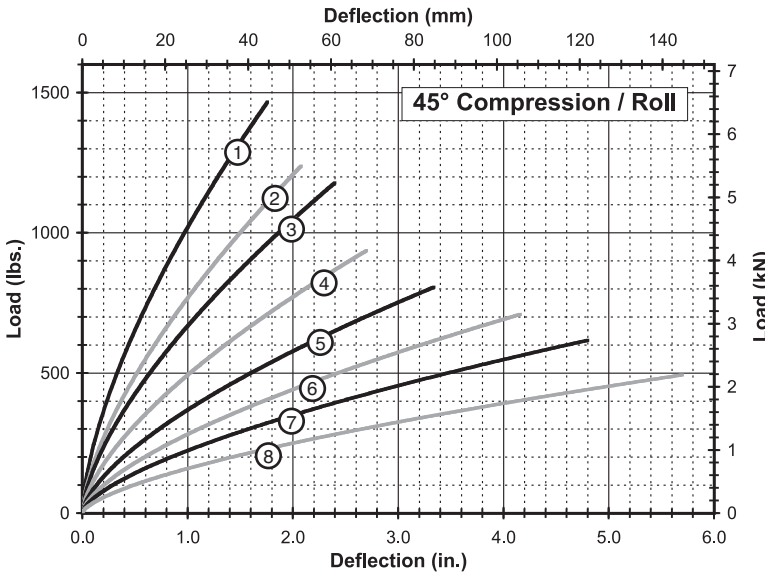

45° Compression/Roll

Curve	Model	Max Static Load lbs. (N)	Max Deflection in. (mm)	Kv (vibration) lbs./in. (kN/m)	Ks (shock) lbs./in. (kN/m)
1	WR16-206-06	435 (1 935)	1.76 (44,7)	2,310 (405)	1,010 (177)
2	WR16-306-06	365 (1 624)	2.08 (52,8)	1,700 (298)	720 (126)
3	WR16-406-06	345 (1 535)	2.40 (61,0)	1,500 (263)	600 (105)
4	WR16-606-06	275 (1 223)	2.70 (68,6)	1,110 (194)	420 (74)
5	WR16-706-06	235 (1 045)	3.34 (84,8)	825 (144)	290 (51)
6	WR16-806-06	205 (912)	4.16 (105,7)	630 (110)	210 (37)
7	WR16-856-06	180 (801)	4.80 (121,9)	500 (88)	160 (28)
8	WR16-906-06	140 (623)	5.70 (144,8)	355 (62)	110 (19)

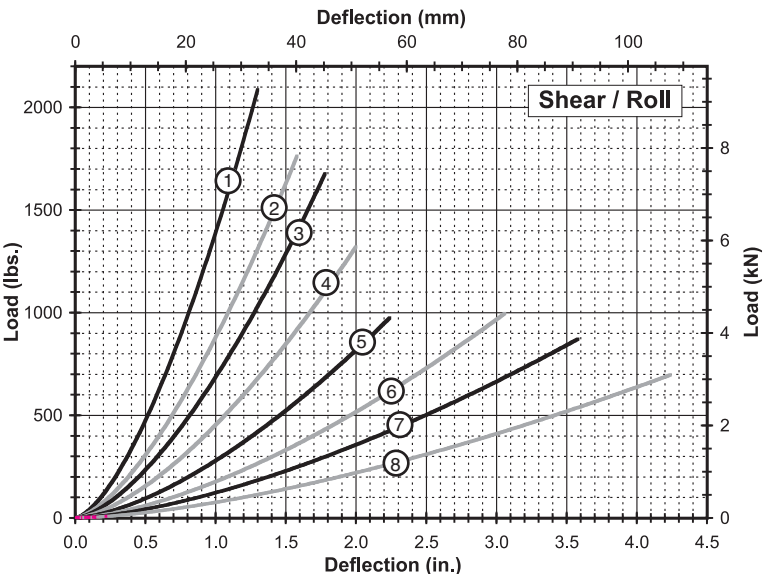

Shear/Roll

Curve	Model	Max Static Load lbs. (N)	Max Deflection in. (mm)	Kv (vibration) lbs./in. (kN/m)	Ks (shock) lbs./in. (kN/m)
1	WR16-206-06	335 (1 490)	1.30 (33,0)	1,260 (221)	1,260 (221)
2	WR16-306-06	275 (1 223)	1.58 (40,1)	890 (156)	890 (156)
3	WR16-406-06	255 (1 134)	1.78 (45,2)	740 (130)	740 (130)
4	WR16-606-06	205 (912)	2.00 (50,8)	520 (91)	520 (91)
5	WR16-706-06	135 (601)	2.24 (56,9)	340 (60)	340 (60)
6	WR16-806-06	100 (445)	3.06 (77,7)	260 (46)	260 (46)
7	WR16-856-06	75 (334)	3.58 (90,9)	190 (33)	190 (33)
8	WR16-906-06	50 (222)	4.24 (107,7)	130 (23)	130 (23)

Note: Performance provided for full loop models with standard (302/304) stainless steel cable. Consult ENIDINE for other options. Do not extrapolate curves.

Technical Data

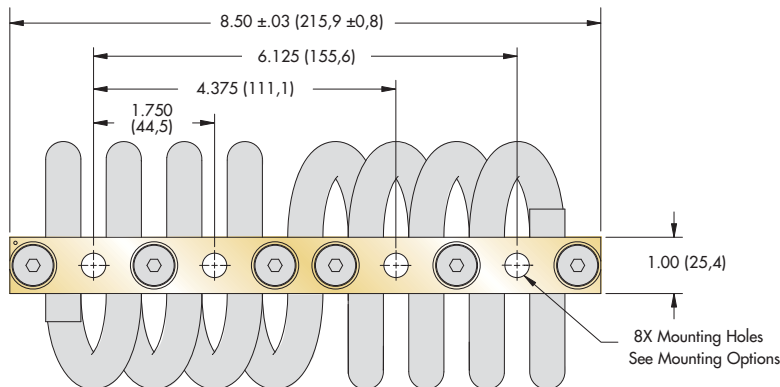

Note: Dimensions are in inches (mm)
Tolerances are ± .010 (± .25mm)

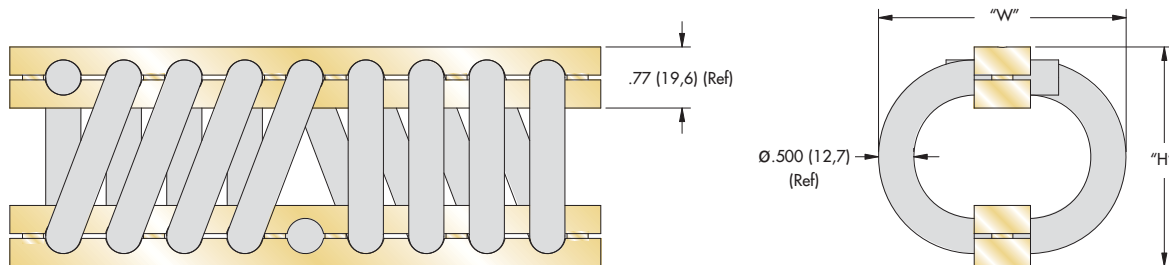

Size	Height "H" in. (mm)	Width (Ref) "W" in. (mm)	Unit Weight Lbs. (Kg)	Mounting Options	Thru Hole in. (mm)	Thread in. (mm)	C'sink Imperial (Metric)
WR16-200	3.00 (76)	3.63 (92)	4.00 (1,81)	A, B, C, D, E, S	Ø.354 ^{+ .005} _{-.015} (Ø9.0 ^{+0.13} _{-0.38})	1/4-28 UNF (M8 X 1,25)	82° (90°)
WR16-300	3.25 (83)	4.00 (102)	4.20 (1,91)				
WR16-400	3.50 (89)	4.13 (105)	4.40 (2,00)				
WR16-600	3.75 (95)	4.75 (121)	4.90 (2,22)				
WR16-700	4.25 (108)	5.25 (133)	5.30 (2,40)				
WR16-800	4.90 (124)	5.65 (144)	5.95 (2,70)				
WR16-850	5.40 (137)	6.13 (156)	6.40 (2,90)				
WR16-900	6.10 (155)	7.10 (180)	6.80 (3,09)				

* Tapped M8 x 1.25, Inserts M7 x 1.0

Model Number Ordering Code

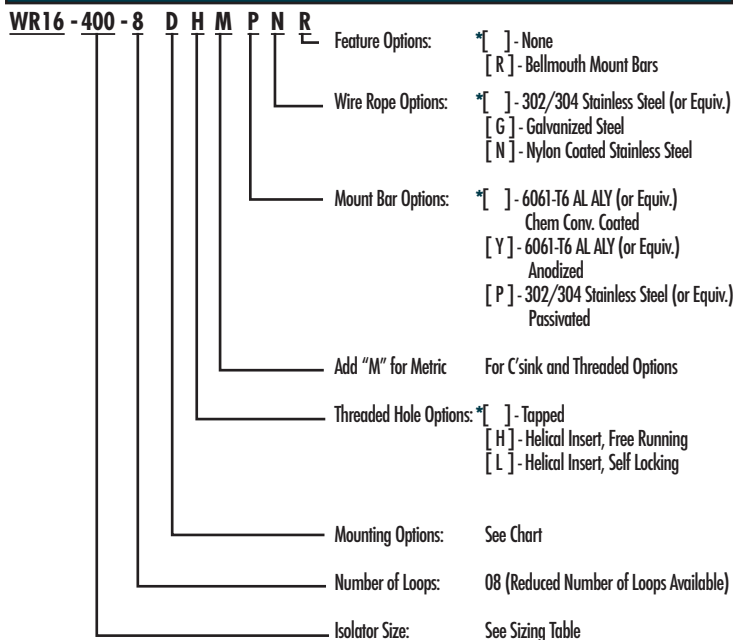

Mounting Options

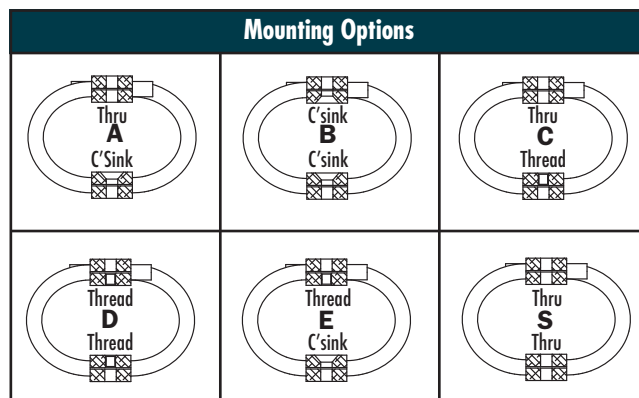

- Maximum recommended torque for threaded bar is 115 in.-lbs. (20 Nm)
- Operating Temperature Range: -150°F to 500°F (-100°C to 260°C)

* Standard features. Any non-standard items may require longer lead times. Call for quotation.

Static Load vs. Deflection

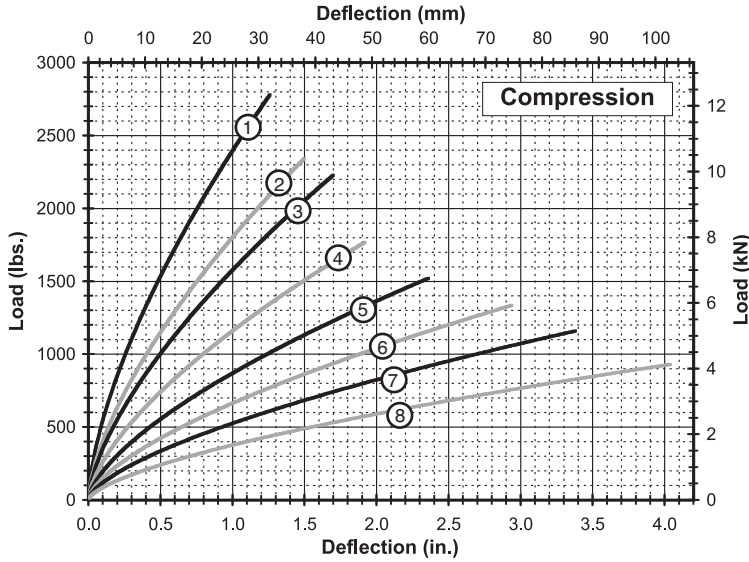

Compression

Curve	Model	Max Static Load Lbs. (N)	Max Deflection in. (mm)	Kv (vibration) Lbs./in. (kN/m)	Ks (shock) Lbs./in. (kN/m)
1	WR16-200-08	820 (3 648)	1.26 (32,0)	5,450 (954)	2,690 (471)
2	WR16-300-08	685 (3 047)	1.50 (38,1)	4,040 (708)	1,900 (333)
3	WR16-400-08	645 (2 869)	1.70 (43,2)	3,500 (613)	1,590 (278)
4	WR16-600-08	520 (2 313)	1.92 (48,8)	2,610 (457)	1,120 (196)
5	WR16-700-08	440 (1 957)	2.36 (59,9)	1,940 (340)	780 (137)
6	WR16-800-08	390 (1 735)	2.94 (74,7)	1,490 (261)	550 (96)
7	WR16-850-08	340 (1 512)	3.38 (85,9)	1,180 (207)	420 (74)
8	WR16-900-08	270 (1 201)	4.04 (102,6)	845 (148)	280 (49)

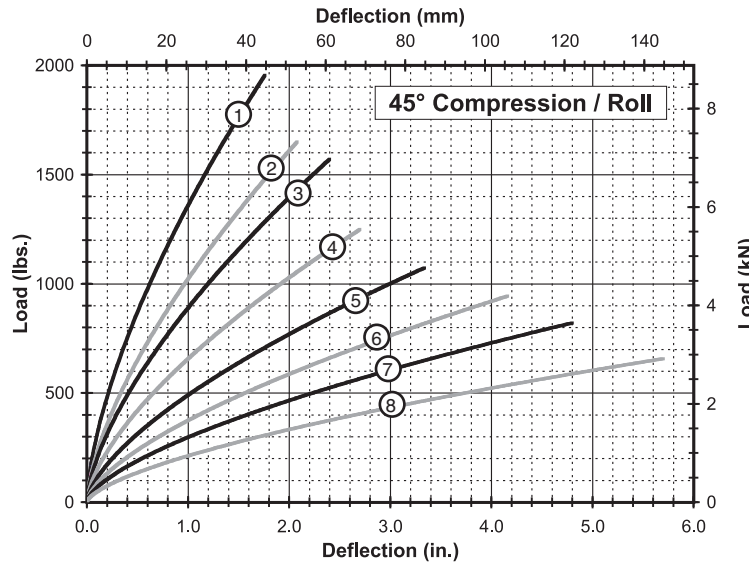

45° Compression/Roll

Curve	Model	Max Static Load Lbs. (N)	Max Deflection in. (mm)	Kv (vibration) Lbs./in. (kN/m)	Ks (shock) Lbs./in. (kN/m)
1	WR16-200-08	580 (2 580)	1.76 (44,7)	3,080 (539)	1,350 (236)
2	WR16-300-08	485 (2 157)	2.08 (52,8)	2,270 (398)	960 (168)
3	WR16-400-08	460 (2 046)	2.40 (61,0)	1,990 (349)	790 (138)
4	WR16-600-08	365 (1 624)	2.70 (68,6)	1,480 (259)	560 (98)
5	WR16-700-08	315 (1 401)	3.34 (84,8)	1,100 (193)	390 (68)
6	WR16-800-08	275 (1 223)	4.16 (105,7)	840 (147)	280 (49)
7	WR16-850-08	240 (1 068)	4.80 (121,9)	670 (117)	210 (37)
8	WR16-900-08	185 (823)	5.70 (144,8)	475 (83)	140 (25)

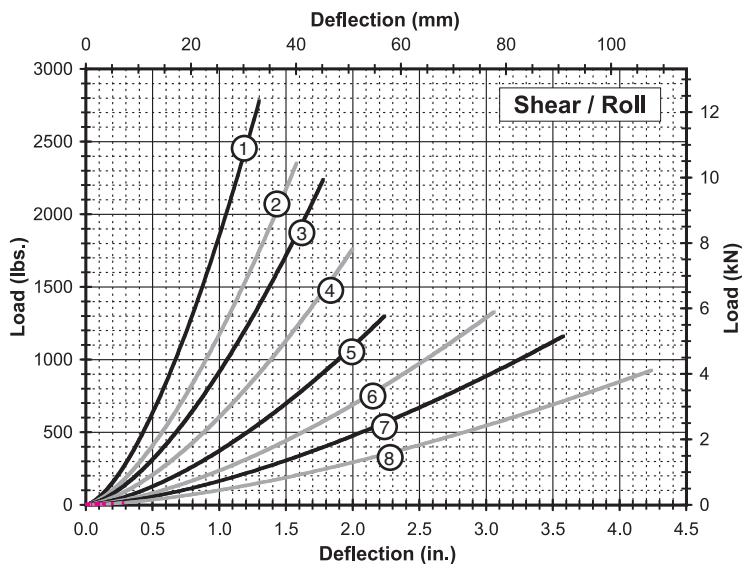

Shear/Roll

Curve	Model	Max Static Load Lbs. (N)	Max Deflection in. (mm)	Kv (vibration) Lbs./in. (kN/m)	Ks (shock) Lbs./in. (kN/m)
1	WR16-200-08	660 (2 936)	1.30 (33,0)	1,680 (294)	1,680 (294)
2	WR16-300-08	385 (1 713)	1.58 (40,1)	1,180 (207)	1,180 (207)
3	WR16-400-08	350 (1 557)	1.78 (45,2)	990 (173)	990 (173)
4	WR16-600-08	270 (1 201)	2.00 (50,8)	690 (121)	690 (121)
5	WR16-700-08	180 (801)	2.24 (56,9)	460 (81)	460 (81)
6	WR16-800-08	135 (601)	3.06 (77,7)	340 (60)	340 (60)
7	WR16-850-08	100 (445)	3.58 (90,9)	260 (46)	260 (46)
8	WR16-900-08	65 (289)	4.24 (107,7)	170 (30)	170 (30)

Note: Performance provided for full loop models with standard (302/304) stainless steel cable.
Consult ENIDINE for other options. Do not extrapolate curves.

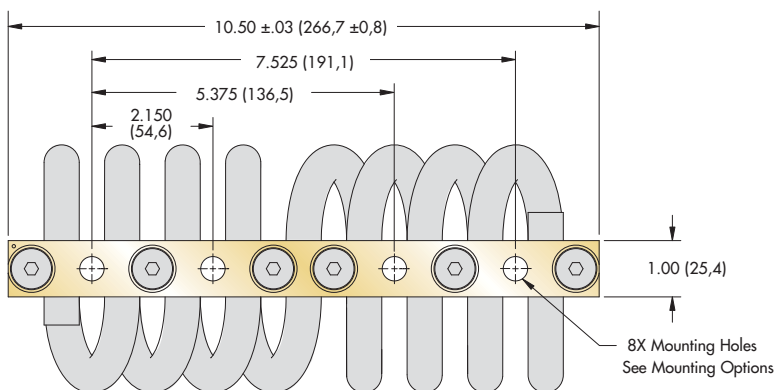

Note: Dimensions are in inches (mm)
Tolerances are ± .010 (± .25mm)

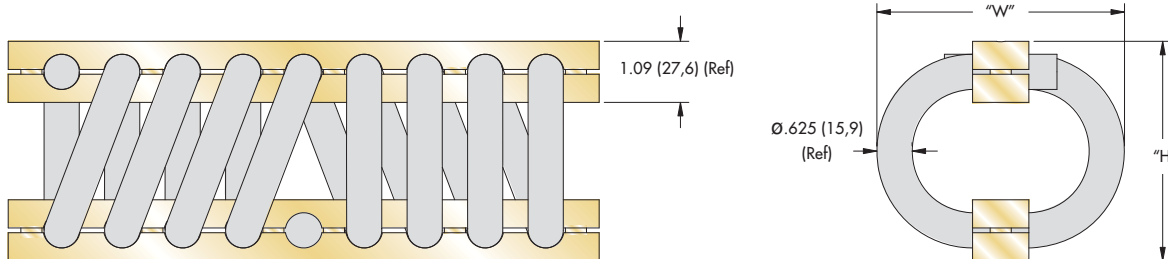

Size	Height "H" in. (mm)	Width (Ref) "W" in. (mm)	Unit Weight Lbs. (Kg)	Mounting Options	Thru Hole in. (mm)	Thread in. (mm)	C'sink Imperial (Metric)
WR20-200	3.50 (89)	4.00 (102)	6.62 (3,00)	C, D	Ø.433 ⁺ .005 Ø11,0 ⁺ 0,13 Ø.38 ⁻	3/8-24 UNF (M10 X 1,5)	82° (90°)
WR20-300	3.90 (99)	4.40 (112)	7.06 (3,20)	A, B, C, D, E, S			
WR20-400	4.00 (102)	4.75 (121)	7.50 (3,40)				
WR20-600	4.30 (109)	5.31 (135)	8.16 (3,70)				
WR20-700	4.70 (119)	6.00 (152)	8.83 (4,00)				
WR20-800	5.00 (127)	6.50 (165)	9.50 (4,31)				
WR20-900	5.30 (135)	7.00 (178)	10.20 (4,63)				

Model Number Ordering Code

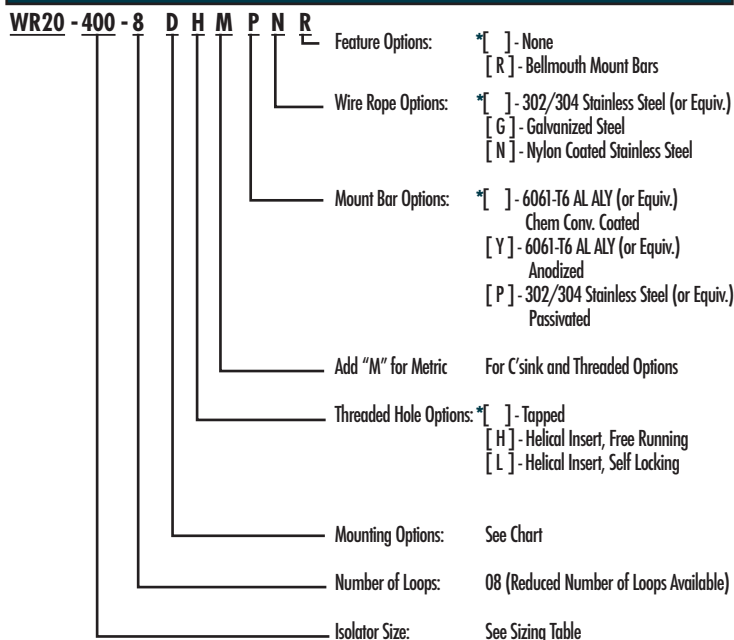

Mounting Options

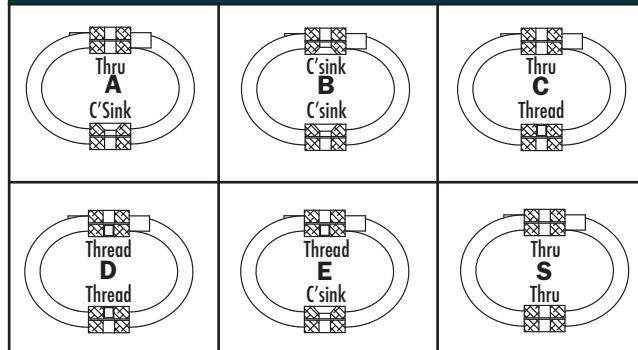

- Maximum recommended torque for threaded bar is 415 in.-lbs. (50 Nm)
- Operating Temperature Range: -150°F to 500°F (-100°C to 260°C)

* Standard features. Any non-standard items may require longer lead times. Call for quotation.

Static Load vs. Deflection

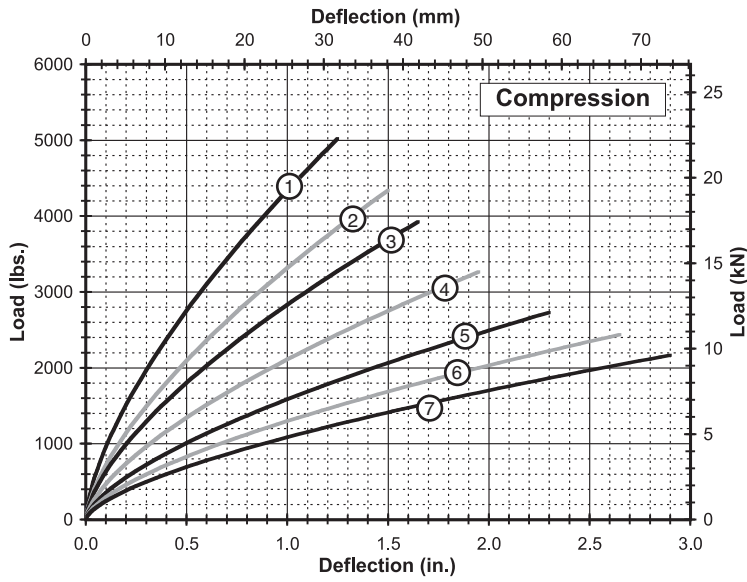

Compression

Curve	Model	Max Static Load Lbs. (N)	Max Deflection in. (mm)	Kv (vibration) Lbs./in. (kN/m)	Ks (shock) Lbs./in. (kN/m)
1	WR20-200-08	1,450 (6 450)	1.25 (31,8)	9,570 (1 676)	4,850 (849)
2	WR20-300-08	1,230 (5 471)	1.50 (38,1)	7,190 (1 259)	3,480 (609)
3	WR20-400-08	1,140 (5 071)	1.65 (41,9)	6,310 (1 105)	2,880 (504)
4	WR20-600-08	945 (4 204)	1.95 (49,5)	4,690 (821)	2,030 (356)
5	WR20-700-08	790 (3 514)	2.30 (58,4)	3,520 (616)	1,440 (252)
6	WR20-800-08	715 (3 180)	2.65 (67,3)	2,920 (511)	1,120 (196)
7	WR20-900-08	630 (2 802)	2.90 (73,7)	2,440 (427)	910 (159)

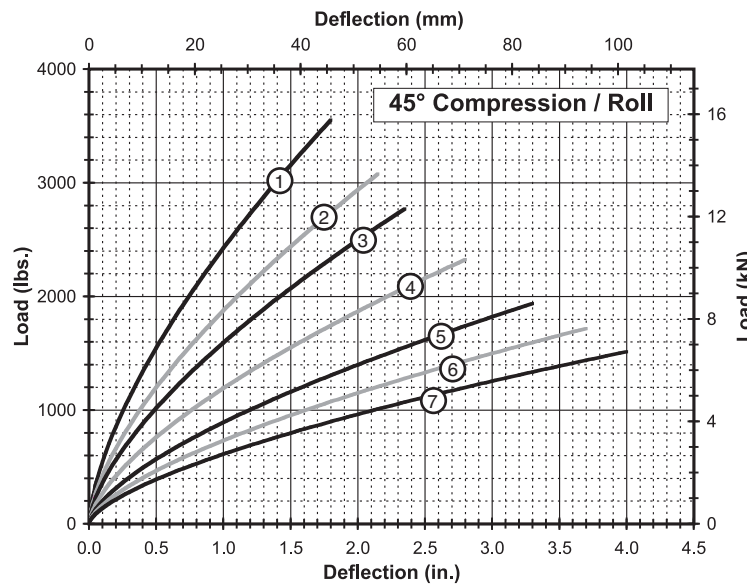

45° Compression/Roll

Curve	Model	Max Static Load Lbs. (N)	Max Deflection in. (mm)	Kv (vibration) Lbs./in. (kN/m)	Ks (shock) Lbs./in. (kN/m)
1	WR20-200-08	1,020 (4 537)	1.80 (45,7)	5,430 (951)	2,390 (419)
2	WR20-300-08	895 (3 981)	2.15 (54,6)	4,230 (741)	1,740 (305)
3	WR20-400-08	805 (3 581)	2.35 (59,7)	3,580 (627)	1,430 (250)
4	WR20-600-08	670 (2 980)	2.80 (71,1)	2,670 (468)	1,010 (177)
5	WR20-700-08	560 (2 491)	3.30 (83,8)	2,000 (350)	710 (124)
6	WR20-800-08	505 (2 246)	3.70 (94,0)	1,630 (285)	560 (98)
7	WR20-900-08	445 (1 979)	4.00 (101,6)	1,360 (238)	460 (81)

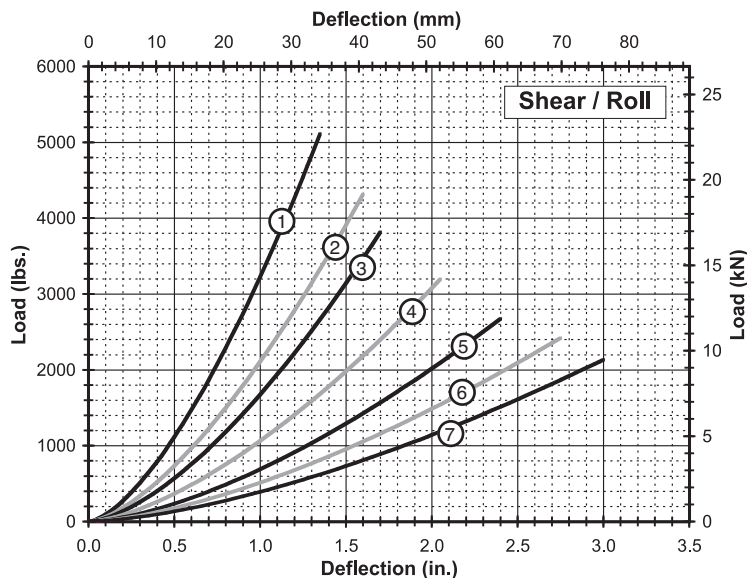

Shear/Roll

Curve	Model	Max Static Load Lbs. (N)	Max Deflection in. (mm)	Kv (vibration) Lbs./in. (kN/m)	Ks (shock) Lbs./in. (kN/m)
1	WR20-200-08	790 (3 514)	1.35 (34,3)	2,990 (524)	2,990 (524)
2	WR20-300-08	680 (3 025)	1.60 (40,6)	2,140 (375)	2,140 (375)
3	WR20-400-08	590 (2 624)	1.70 (43,2)	1,760 (308)	1,760 (308)
4	WR20-600-08	480 (2 135)	2.05 (52,1)	1,230 (215)	1,230 (215)
5	WR20-700-08	340 (1 512)	2.40 (61,0)	870 (152)	870 (152)
6	WR20-800-08	275 (1 223)	2.75 (69,9)	700 (123)	700 (123)
7	WR20-900-08	220 (979)	3.00 (76,2)	560 (98)	560 (98)

Note: Performance provided for full loop models with standard (302/304) stainless steel cable. Consult ENIDINE for other options. Do not extrapolate curves.

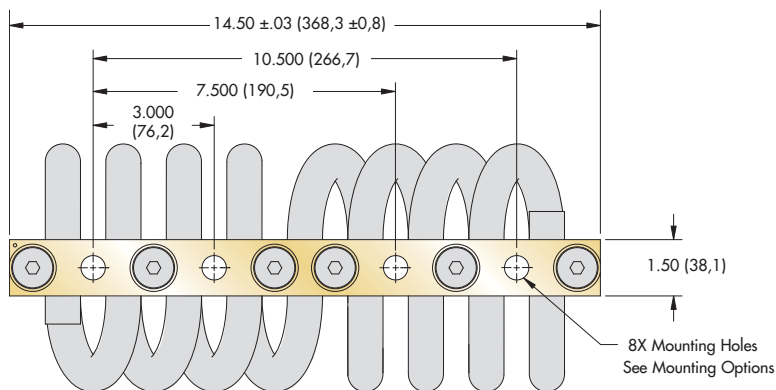

Note: Dimensions are in inches (mm)
Tolerances are ± .010 (± .25mm)

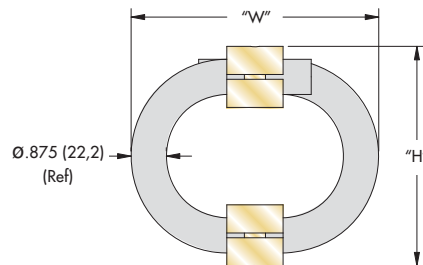
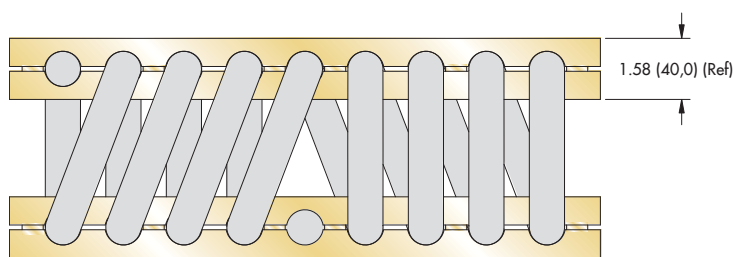

Size	Height "H" in. (mm)	Width (Ref) "W" in. (mm)	Unit Weight Lbs. (Kg)	Mounting Options	Thru Hole in. (mm)	Thread in. (mm)	C'sink Imperial (Metric)
WR28-200	5.25 (133)	5.50 (140)	18.5 (8,40)	C, D	$\begin{matrix} \text{Ø.531} & + & .005 \\ & - & .015 \end{matrix}$ $\begin{matrix} (\text{Ø}13,5 & + & 0,13 \\ & - & 0,38) \end{matrix}$	1/2-13 UNC (M12 X 1,75)	82° (90°)
WR28-400	6.00 (152)	6.50 (165)	21.0 (9,53)	A, B, C, D, E, S			
WR28-600	6.25 (159)	7.00 (178)	21.8 (9,90)				
WR28-800	7.50 (191)	8.25 (210)	25.3 (11,50)				
WR28-900	8.50 (216)	9.25 (235)	28.0 (12,70)				
WR28-950	8.50 (216)	11.25 (286)	30.6 (13,90)				

Model Number Ordering Code

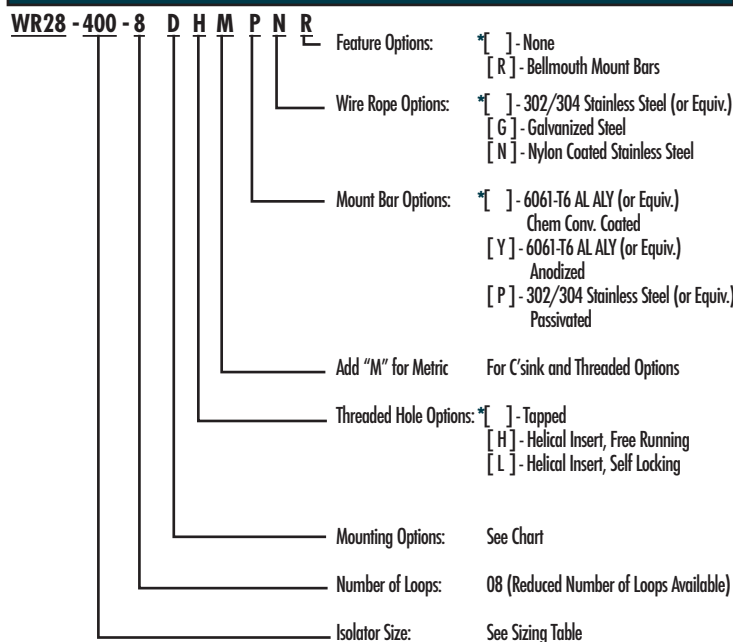

Mounting Options

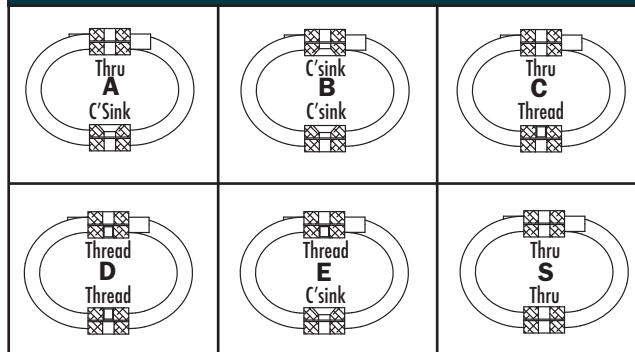

- Maximum recommended torque for threaded bar 95 ft.-lbs. (100 Nm)
- Operating Temperature Range: -150°F to 500°F (-100°C to 260°C)

* Standard features. Any non-standard items may require longer lead times. Call for quotation.

Static Load vs. Deflection

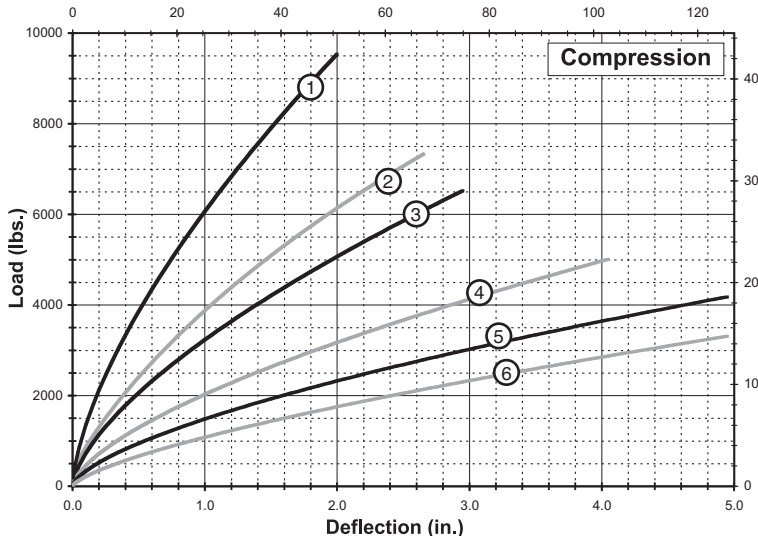

Compression

Curve	Model	Max Static Load Lbs. (kN)	Max Deflection in. (mm)	Kv (vibration) Lbs./in. (kN/m)	Ks (shock) Lbs./in. (kN/m)
1	WR28-200-08	2,760 (12,28)	2.00 (50,8)	13,490 (2 362)	5,770 (1 010)
2	WR28-400-08	2,120 (9,43)	2.65 (67,3)	8,640 (1 513)	3,340 (585)
3	WR28-600-08	1,900 (8,45)	2.95 (74,9)	7,250 (1 270)	2,680 (469)
4	WR28-800-08	1,470 (6,54)	4.05 (102,9)	4,570 (800)	1,500 (263)
5	WR28-900-08	1,220 (5,43)	4.95 (125,7)	3,340 (585)	1,030 (180)
6	WR28-950-08	840 (3,74)	4.95 (125,7)	2,150 (377)	790 (138)

45° Compression / Roll

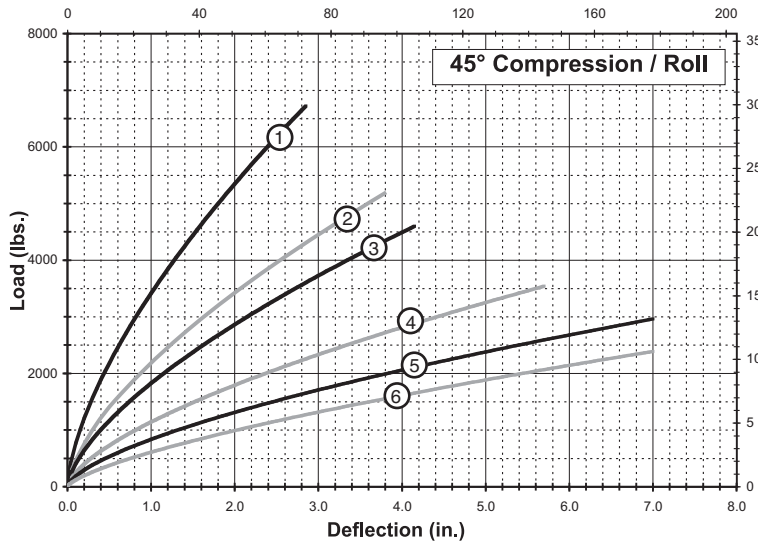

45° Compression / Roll

Curve	Model	Max Static Load Lbs. (kN)	Max Deflection in. (mm)	Kv (vibration) Lbs./in. (kN/m)	Ks (shock) Lbs./in. (kN/m)
1	WR28-200-08	1,960 (8,72)	2.85 (72,4)	7,700 (1 348)	2,870 (503)
2	WR28-400-08	1,500 (6,67)	3.80 (96,5)	4,910 (860)	1,650 (289)
3	WR28-600-08	1,350 (6,01)	4.15 (105,4)	4,100 (718)	1,340 (235)
4	WR28-800-08	1,000 (4,45)	5.70 (144,8)	2,560 (448)	750 (131)
5	WR28-900-08	730 (3,25)	7.00 (177,8)	1,870 (327)	510 (89)
6	WR28-950-08	475 (2,11)	7.00 (177,8)	1,210 (212)	400 (70)

Shear / Roll

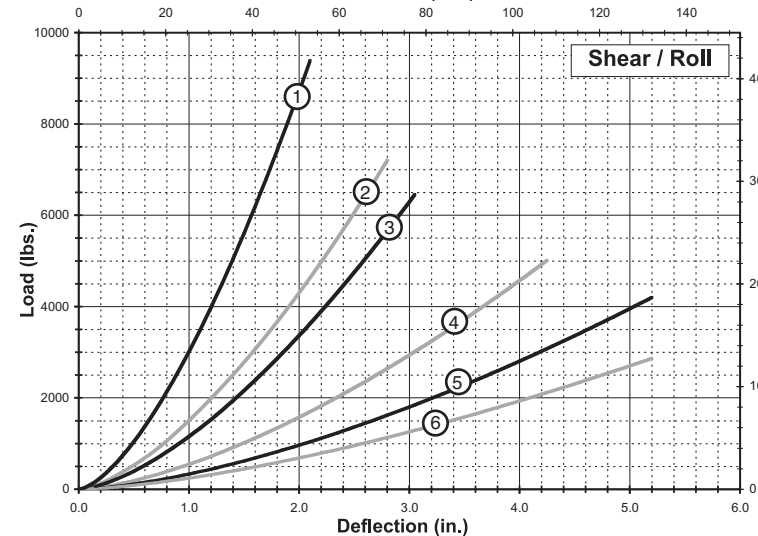

Shear / Roll

Curve	Model	Max Static Load Lbs. (kN)	Max Deflection in. (mm)	Kv (vibration) Lbs./in. (kN/m)	Ks (shock) Lbs./in. (kN/m)
1	WR28-200-08	1,380 (6,14)	2.10 (53,3)	3,530 (618)	3,530 (618)
2	WR28-400-08	795 (3,54)	2.80 (71,1)	2,030 (356)	2,030 (356)
3	WR28-600-08	650 (2,89)	3.05 (77,5)	1,660 (291)	1,660 (291)
4	WR28-800-08	365 (1,62)	4.25 (108,0)	930 (163)	930 (163)
5	WR28-900-08	250 (1,11)	5.20 (132,1)	640 (112)	640 (112)
6	WR28-950-08	170 (0,76)	5.20 (132,1)	440 (77)	440 (77)

Note: Performance provided for full loop models with standard (302/304) stainless steel cable. Consult ENIDINE for other options. Do not extrapolate curves.

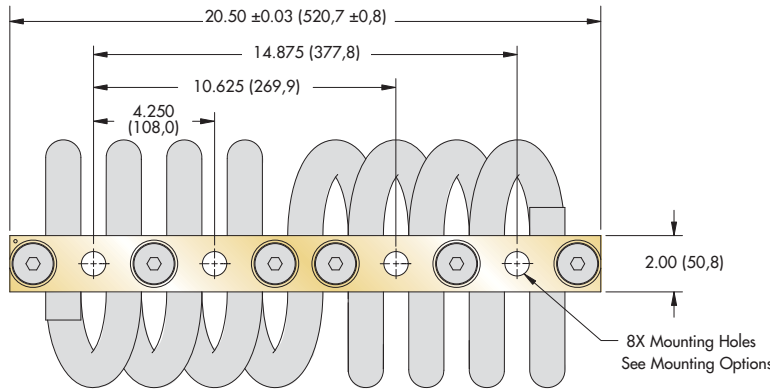

Note: Dimensions are in inches (mm)
Tolerances are ± .010 (± .25mm)

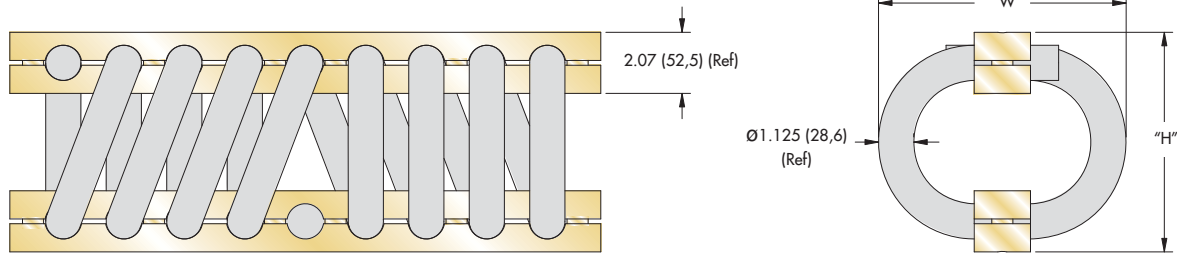

Size	Height "H" in. (mm)	Width "W" in. (mm)	Unit Weight Lbs. (Kg)	Mounting Options	Thru Hole in. (mm)	Thread in. (mm)	C'sink Imperial (Metric)
WR36-200	7.00 (178)	8.50 (216)	46 (20,9)	A, B, C, D, E, S	0.781 + .005 - .015 (Ø19.8 + 0,13 - 0,38)	3/4-10 UNC (M18 X 2,5)	82° (90°)
WR36-400	8.50 (216)	9.50 (241)	53 (24,0)				
WR36-600	9.25 (235)	10.25 (260)	55 (25,0)				

Model Number Ordering Code

WR36 - 400 - 8 D H M P N R

- Feature Options:** * [] - None; [R] - Bellmouth Mount Bars
- Wire Rope Options:** * [] - 302/304 Stainless Steel (or Equiv.); [G] - Galvanized Steel; [N] - Nylon Coated Stainless Steel
- Mount Bar Options:** * [] - 6061-T6 AL ALY (or Equiv.) Chem Conv. Coated; [Y] - 6061-T6 AL ALY (or Equiv.) Anodized; [P] - 302/304 Stainless Steel (or Equiv.) Passivated
- Add "M" for Metric For C'sink and Threaded Options
- Threaded Hole Options:** * [] - Tapped; [H] - Helical Insert, Free Running; [L] - Helical Insert, Self Locking
- Mounting Options:** See Chart
- Number of Loops:** 08 (Reduced Number of Loops Available)
- Isolator Size:** See Sizing Table

Mounting Options

- Maximum recommended torque for threaded bar is 300 ft.-lbs. (300 Nm)
- Operating Temperature Range: -150°F to 500°F (-100°C to 260°C)

* Standard features. Any non-standard items may require longer lead times. Call for quotation.

Static Load vs. Deflection

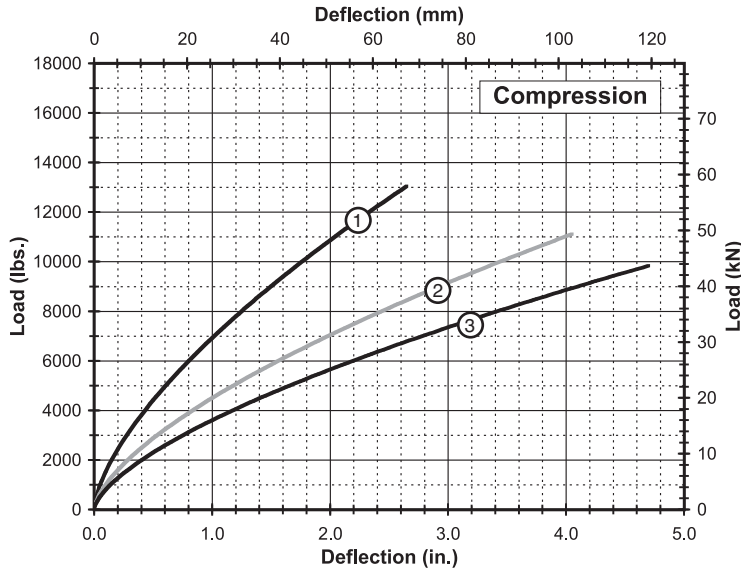

Compression

Curve	Model	Max Static Load Lbs. (kN)	Max Deflection in. (mm)	Kv (vibration) Lbs./in. (kN/m)	Ks (shock) Lbs./in. (kN/m)
1	WR36-200-08	3,790 (16,86)	2.65 (67,3)	15,450 (2 706)	5,960 (1 044)
2	WR36-400-08	3,260 (14,50)	4.05 (102,9)	10,130 (1 774)	3,330 (583)
3	WR36-600-08	2,870 (12,77)	4.70 (119,4)	8,080 (1 415)	2,540 (445)

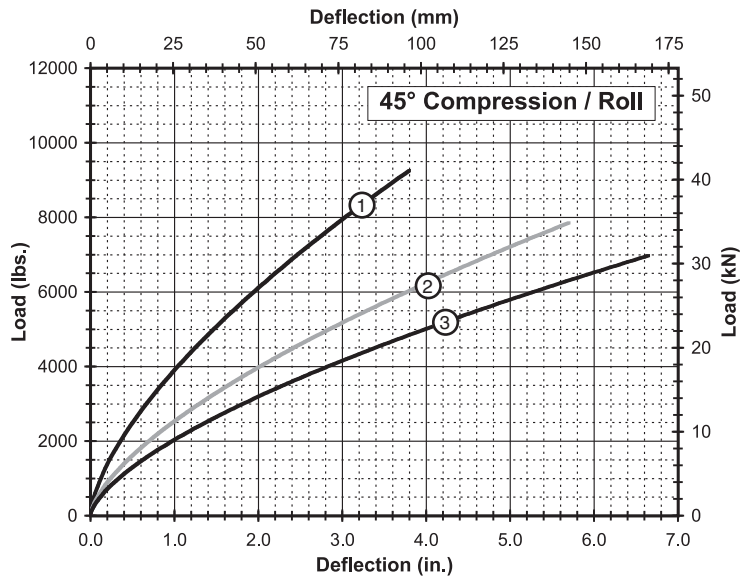

45° Compression/Roll

Curve	Model	Max Static Load Lbs. (kN)	Max Deflection in. (mm)	Kv (vibration) Lbs./in. (kN/m)	Ks (shock) Lbs./in. (kN/m)
1	WR36-200-08	2,690 (11,97)	3.80 (96,5)	8,800 (1 541)	2,960 (518)
2	WR36-400-08	2,220 (9,88)	5.70 (144,8)	5,670 (993)	1,670 (292)
3	WR36-600-08	1,790 (7,96)	6.65 (168,9)	4,560 (799)	1,270 (222)

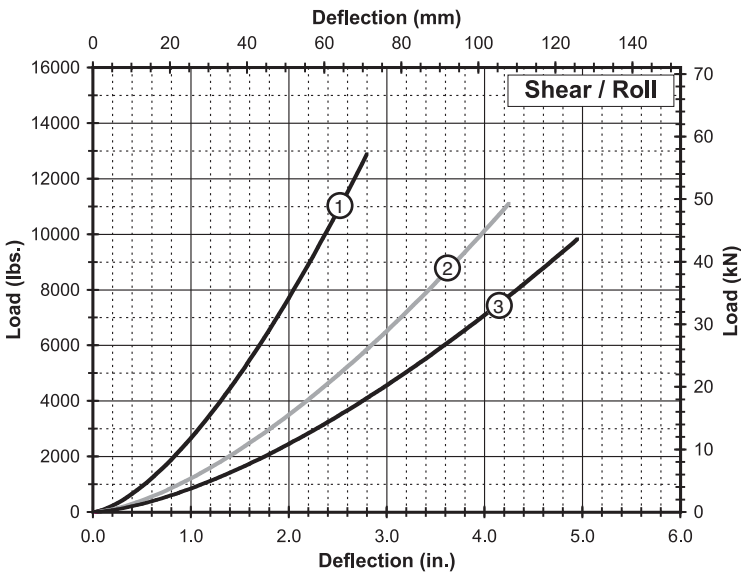

Shear/Roll

Curve	Model	Max Static Load Lbs. (kN)	Max Deflection in. (mm)	Kv (vibration) Lbs./in. (kN/m)	Ks (shock) Lbs./in. (kN/m)
1	WR36-200-08	1,420 (6,32)	2.80 (71,1)	3,630 (636)	3,630 (636)
2	WR36-400-08	810 (3,60)	4.25 (108,0)	2,060 (361)	2,060 (361)
3	WR36-600-08	615 (2,74)	4.95 (125,7)	1,570 (275)	1,570 (275)

Note: Performance provided for full loop models with standard (302/304) stainless steel cable.
Consult ENIDINE for other options. Do not extrapolate curves.

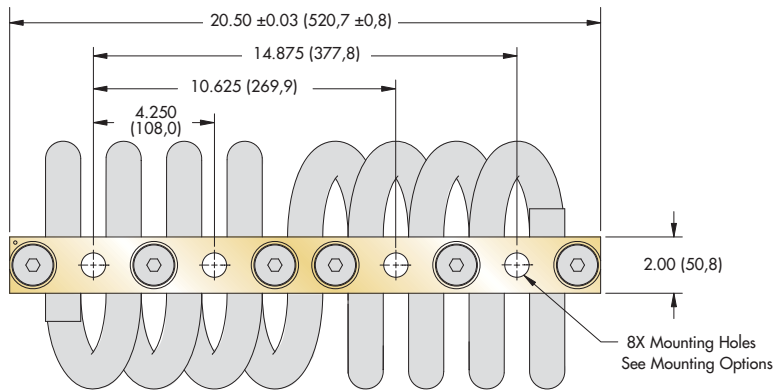

Note: Dimensions are in inches (mm)
Tolerances are ± .010 (± .25mm)

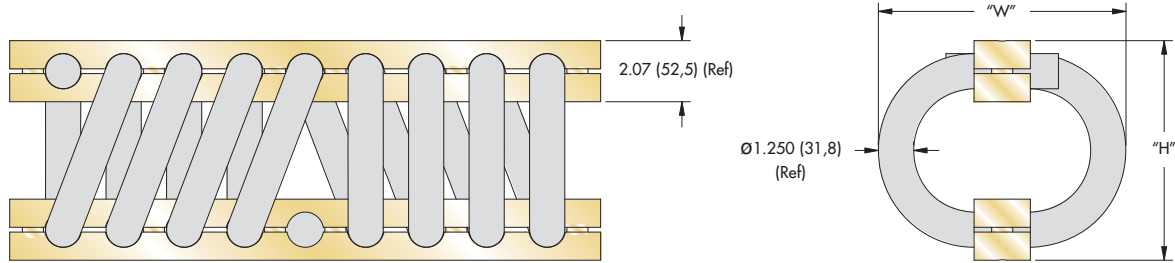

Size	Height "H" in. (mm)	Width "W" in. (mm)	Unit Weight Lbs. (Kg)	Mounting Options	Thru Hole in. (mm)	Thread in. (mm)	C'sink Imperial (Metric)
WR40-200	7.00 (178)	8.25 (210)	53 (24,0)	A, B, C, D, E, S	Ø.781 ^{+0,005} _{-.015}	3/4-10 UNC	82°
WR40-400	8.50 (216)	9.75 (248)	60 (27,2)		Ø19.8 ^{+0,13} _{-0,38}	(M18 X 2,5)	(90°)

Model Number Ordering Code

WR40 - 400 - 8 D H M P N R

- Feature Options: * [] - None [R] - Bellmouth Mount Bars
- Wire Rope Options: * [] - 302/304 Stainless Steel (or Equiv.) [G] - Galvanized Steel [N] - Nylon Coated Stainless Steel
- Mount Bar Options: * [] - 6061-T6 AL ALY (or Equiv.) Chem Conv. Coated [Y] - 6061-T6 AL ALY (or Equiv.) Anodized [P] - 302/304 Stainless Steel (or Equiv.) Passivated
- Add "M" for Metric For C'sink and Threaded Options
- Threaded Hole Options: * [] - Tapped [H] - Helical Insert, Free Running [L] - Helical Insert, Self Locking
- Mounting Options: See Chart
- Number of Loops: 08 (Reduced Number of Loops Available)
- Isolator Size: See Sizing Table

Mounting Options

- Maximum recommended torque for threaded bar is 300 ft.-lbs. (300 Nm)
- Operating Temperature Range: -150°F to 500°F (-100°C to 260°C)

* Standard features. Any non-standard items may require longer lead times. Call for quotation.

Static Load vs. Deflection

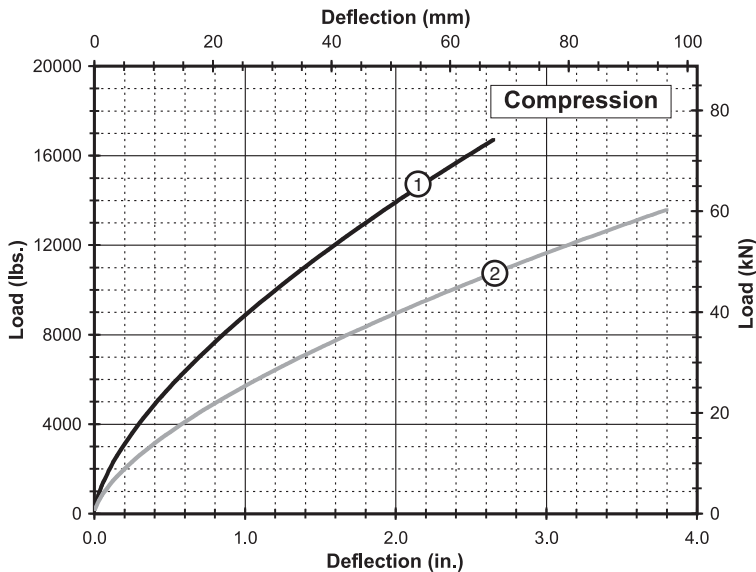

Compression

Curve	Model	Max Static Load Lbs. (kN)	Max Deflection in. (mm)	Kv (vibration) Lbs./in. (kN/m)	Ks (shock) Lbs./in. (kN/m)
1	WR40-200-08	4,860 (21,62)	2.65 (67,3)	19,800 (3 468)	7,640 (1 338)
2	WR40-400-08	3,960 (17,61)	3.80 (96,5)	12,770 (2 236)	4,330 (758)

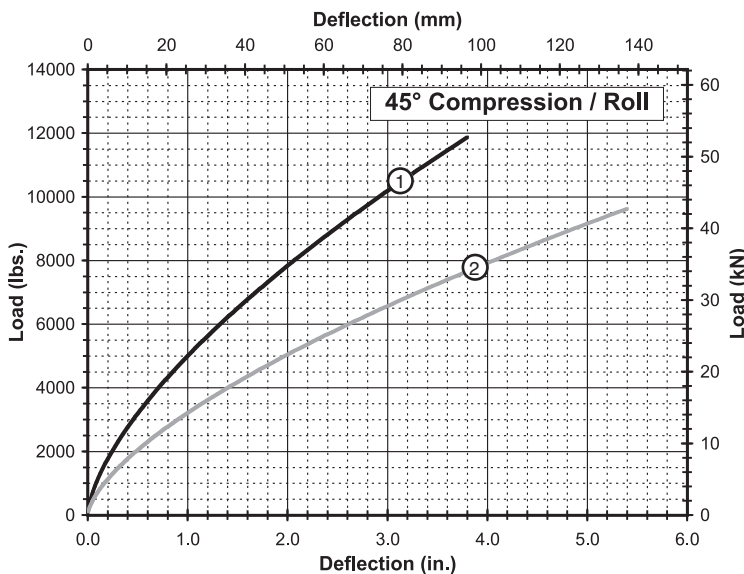

45° Compression/Roll

Curve	Model	Max Static Load Lbs. (kN)	Max Deflection in. (mm)	Kv (vibration) Lbs./in. (kN/m)	Ks (shock) Lbs./in. (kN/m)
1	WR40-200-08	3,440 (15,30)	3.80 (96,5)	11,240 (1 968)	3,790 (664)
2	WR40-400-08	2,790 (12,41)	5.40 (137,2)	7,170 (1 256)	2,160 (378)

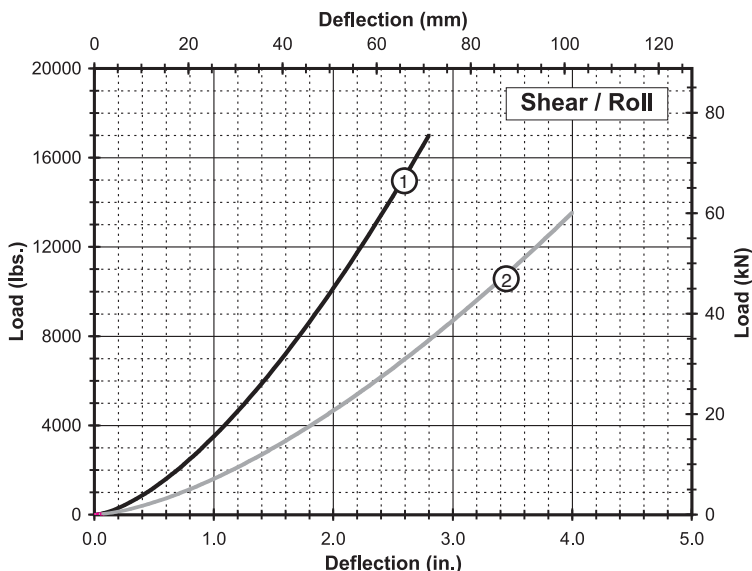

Shear/Roll

Curve	Model	Max Static Load Lbs. (kN)	Max Deflection in. (mm)	Kv (vibration) Lbs./in. (kN/m)	Ks (shock) Lbs./in. (kN/m)
1	WR40-200-08	1,870 (8,32)	2.80 (71,1)	4,790 (839)	4,790 (839)
2	WR40-400-08	1,044 (4,64)	4.00 (101,6)	2,670 (468)	2,670 (468)

Note: Performance provided for full loop models with standard (302/304) stainless steel cable. Consult ENIDINE for other options. Do not extrapolate curves.



Compact Wire Rope Isolators

For the best in vibration isolation capabilities, choose Enidine's Compact Wire Rope Isolators. Smaller than traditional wire ropes, these unique isolators provide cost-effective, simultaneous shock and vibration attenuation where package space is at a premium.

Enidine Compact Wire Rope Isolators feature an easy, single-point installation, which allows them to be installed in virtually any application. Their small size also permits the isolation of individual system components, making them ideal for use in sensitive equipment and electronics. Just as with our standard Enidine Wire Rope Isolators, Enidine Compact Wire Rope Isolators feature a patented, all-metal design and components that ensure maximum reliability, regardless of temperature or substrate requirement, and that can help meet MILSPECS similar to those of our Wire Rope Isolator series. Please refer to our "Compact Wire Rope Isolator Sizing Information" on pages 37-38 for more information.

If your application is outside the standard Compact Wire Rope Isolator product range, please consult the standard Wire Rope Isolator or HERM portions of this catalog. If a standard solution is still not available, Enidine engineers can design an isolator to suit your specifications.

For further information on Enidine Wire Rope, HERM and Compact Wire Rope Isolator products, technical assistance and pricing, please contact Enidine or your nearest authorized distributor. A list of Enidine distributors can be found by visiting our website at www.enidine.com.

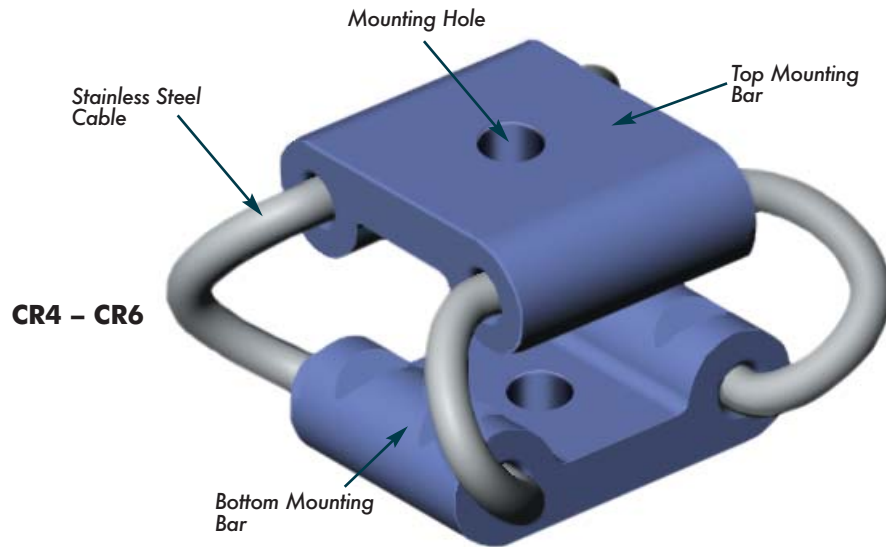
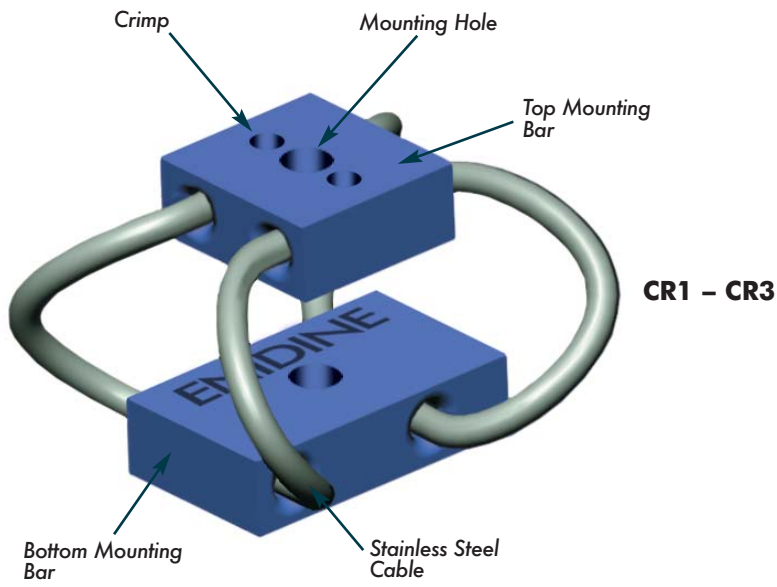

Materials and Finishes:

Standard: Wire Rope: 302/304 Stainless Steel
Mount Bars: 6061-T6 Aluminum, Chemical Conversion Coated per MIL-C-5541, Class 1A
Threads: Tapped

Optional: Mount Bars: 6061-T6 Aluminum, Anodized per MIL-A-8625, Type II, Class 1
302/304 Stainless Steel per ASTM A276, Passivated

Special: Consult Enidine

Isolator Options:

Mounting: Enidine offers a full range of mounting combinations of thru-hole, countersunk, and threaded bars. All configurations are available in either Imperial or Metric styles. Add an "M" after the mounting option for Metric. Some models have reduced mounting options available due to limited fastener installation space. Consult Enidine if a preferred mounting configuration is not listed.

Bellmouth: The bellmouth feature includes mount bars with radii manufactured into the wire rope hole edges. This option is recommended for high fatigue applications. Compact rope models (CR1 – CR6) include this feature as the standard.

Performance:**Stiffness (Kv or Ks):**

Compact wire rope isolators exhibit non-linear stiffness behavior. Small deflections, usually associated with vibration isolation, will have a different spring rate than larger shock deflections. Enidine publishes typical vibration stiffness values (Kv), and average shock stiffness values (Ks) within the catalog. These values can be used with the provided equations listed on Page 38 to predict system performance.

Isolator Axes:

Compact wire rope isolators are multi-axis isolators. The diagram below includes load axis definitions and deflection considerations.

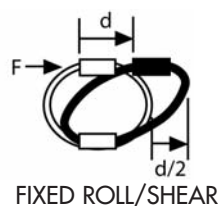
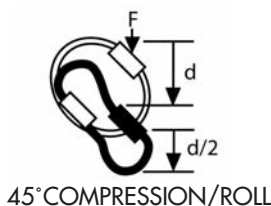
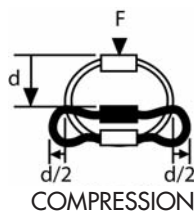

Damping: Typically 5-15%, depending on size and input level. For specific damping considerations, please consult Enidine.

Mounting Orientation:

The diagrams below illustrate typical mounting orientations.

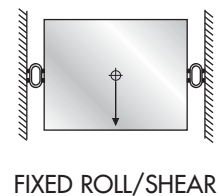
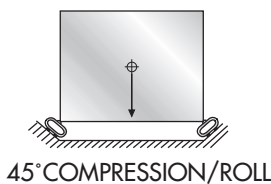
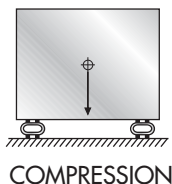
**Stabilizers:**

Stabilizers are used to control deflections of tall supported masses. Stabilizers are typically recommended when the height equals 2-times the width or depth dimension. In most applications, the quantity of stabilizers required are half as many as the base isolators, and selected one size softer than the base isolators.

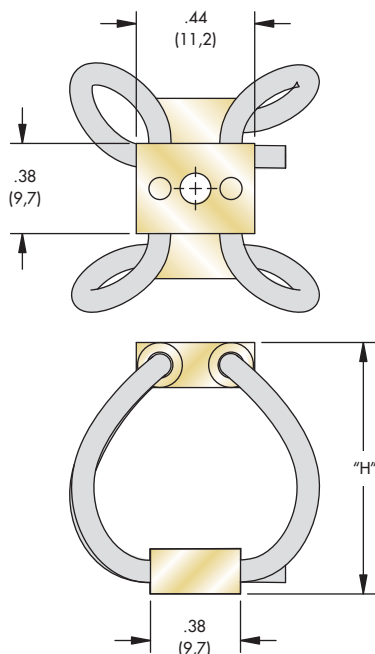

Note: Dimensions are in inches (mm)
Tolerances are ± .010 (± .25mm)

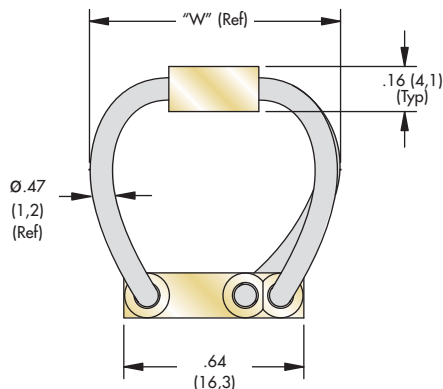

Size	Height "H" in. (mm)	Width (Ref) "W" in. (mm)	Unit Weight Lbs. (Kg)	Mounting Options	Thru Hole in. (mm)	Thread in. (mm)	C'sink Imperial (Metric)
CR1-100	0.66 (17)	0.73 (19)	0.11 (3,1)	A, B, C, D, E, S	Ø.130 (Ø3,30)	#4-40 UNC (M3 X 0,5)	82° (90°)
CR1-200	0.75 (19)	0.79 (20)	0.11 (3,1)				
CR1-300	0.90 (23)	0.91 (23)	0.12 (3,4)				
CR1-400	1.04 (26)	1.03 (26)	0.12 (3,4)				

Model Number Ordering Code

CR1 - 400 - D M P

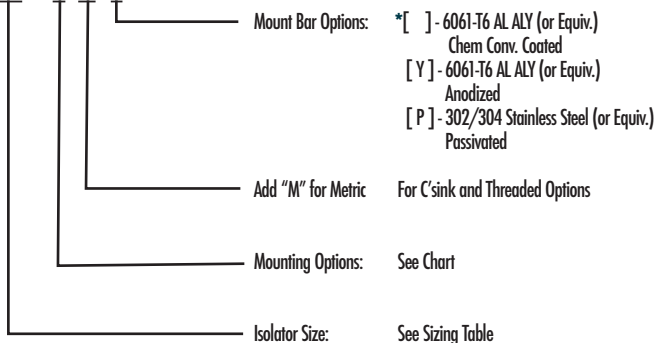

Mounting Options

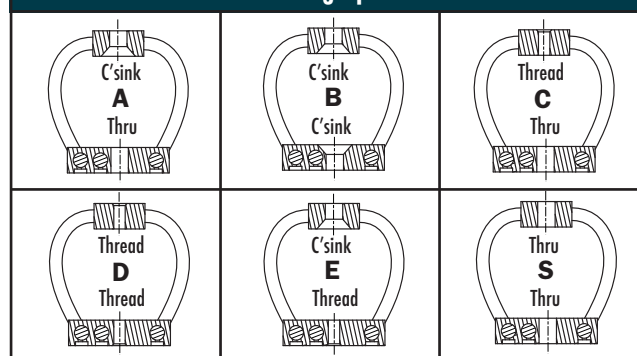

* Standard features. Any non-standard items may require longer lead times. Call for quotation.

- Maximum recommended torque for tapped aluminum bar is 10 in.-lbs. (1,2 Nm)
- Wire Rope Material: Stranded 300 series stainless steel
- Operating Temperature Range: -150°F to 500°F (-100°C to 260°C)
- U.S. Patent 6,290,217

Static Load vs. Deflection

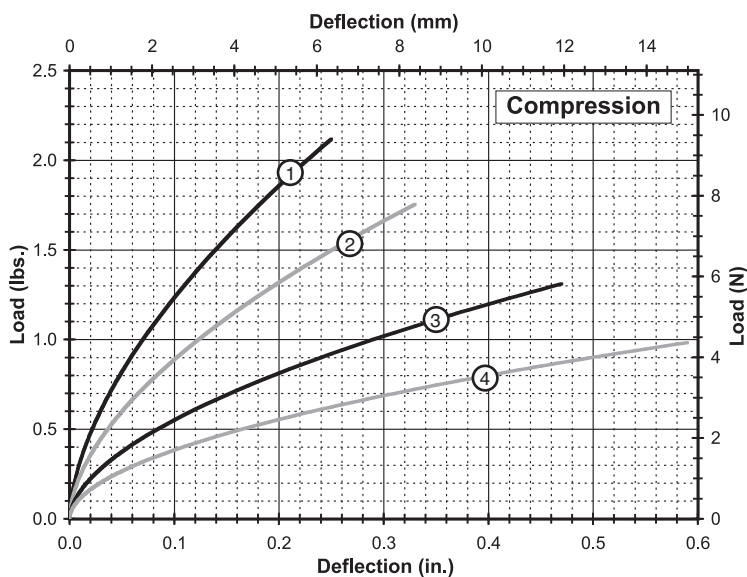

Compression

Curve	Model	Max Static Load Lbs. (N)	Max Deflection in. (mm)	Kv (vibration) Lbs./in. (kN/m)	Ks (shock) Lbs./in. (kN/m)
1	CR1-100	0.75 (3,3)	0.25 (6,4)	22 (3,9)	11 (1,9)
2	CR1-200	0.55 (2,4)	0.33 (8,4)	16 (2,8)	7.0 (1,2)
3	CR1-300	0.40 (1,8)	0.47 (11,9)	10 (1,75)	3.5 (0,61)
4	CR1-400	0.30 (1,3)	0.59 (15,0)	7.5 (1,31)	2.2 (0,39)

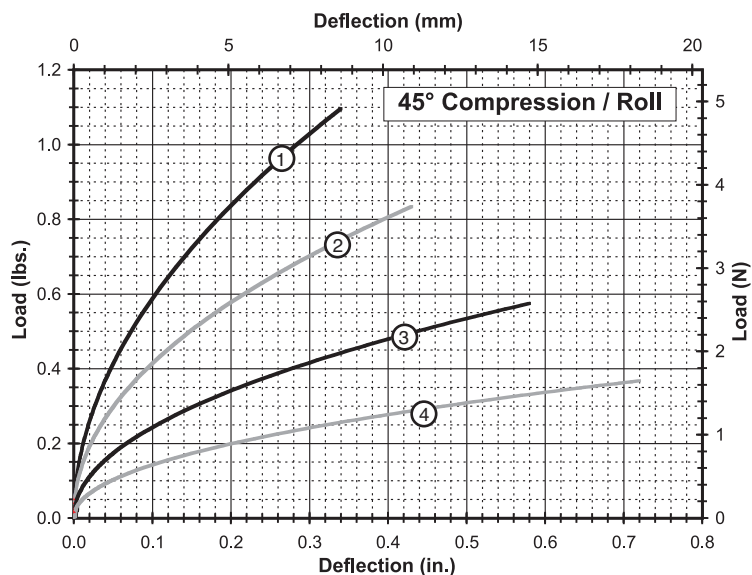

45° Compression/Roll

Curve	Model	Max Static Load Lbs. (N)	Max Deflection in. (mm)	Kv (vibration) Lbs./in. (kN/m)	Ks (shock) Lbs./in. (kN/m)
1	CR1-100	0.35 (1,6)	0.34 (8,6)	12 (2,1)	4.5 (0,79)
2	CR1-200	0.25 (1,1)	0.43 (10,9)	8.5 (1,5)	2.5 (0,44)
3	CR1-300	0.17 (0,76)	0.58 (14,7)	5.0 (0,88)	1.5 (0,26)
4	CR1-400	0.11 (0,49)	0.72 (18,3)	3.0 (0,53)	0.7 (0,12)

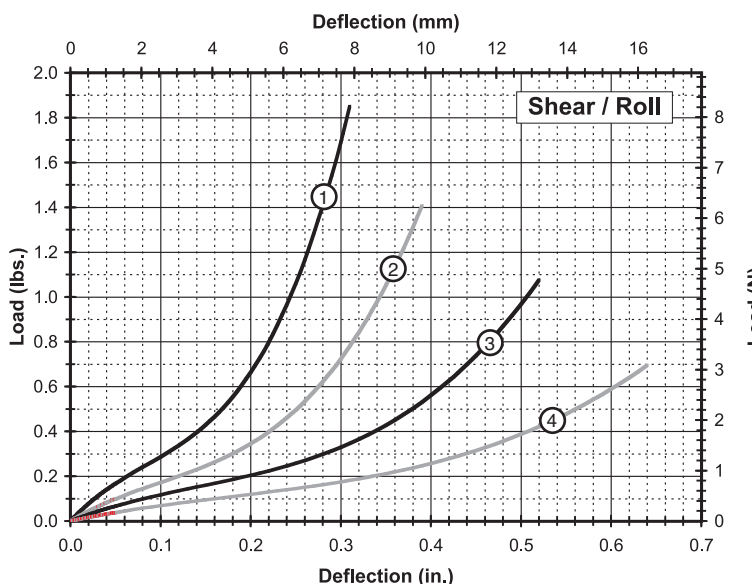

Shear/Roll

Curve	Model	Max Static Load Lbs. (N)	Max Deflection in. (mm)	Kv (vibration) Lbs./in. (kN/m)	Ks (shock) Lbs./in. (kN/m)
1	CR1-100	0.25 (1,1)	0.31 (7,9)	4.0 (0,70)	4.0 (0,70)
2	CR1-200	0.20 (0,89)	0.39 (9,9)	2.5 (0,44)	2.5 (0,44)
3	CR1-300	0.16 (0,71)	0.52 (13,2)	1.5 (0,26)	1.5 (0,26)
4	CR1-400	0.12 (0,53)	0.64 (16,3)	0.8 (0,13)	0.8 (0,13)

Note: Do not extrapolate plotted curves.

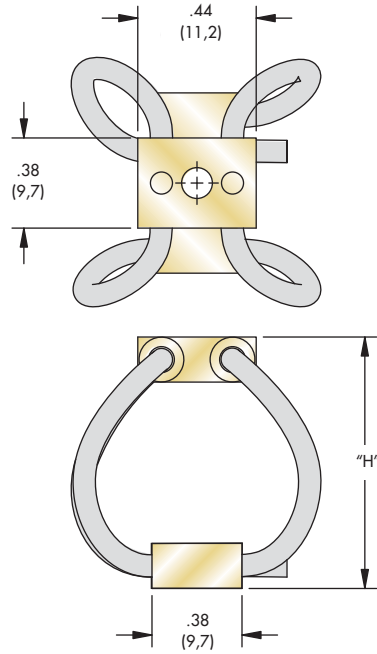

Note: Dimensions are in inches (mm)
Tolerances are ± .010 (± .25mm)

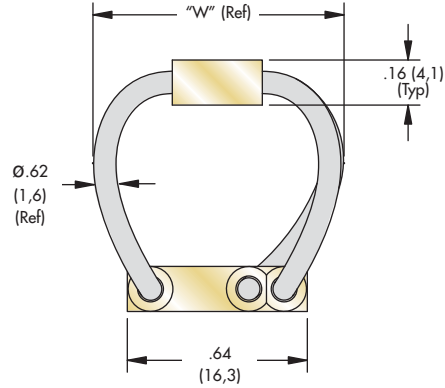

Size	Height "H" in. (mm)	Width "W" in. (mm)	Unit Weight Lbs. (Kg)	Mounting Options	Thru Hole in. (mm)	Thread in. (mm)	C'sink Imperial (Metric)
CR2-100	0.64 (16)	0.78 (20)	0.13 (3,7)	A, B, C, D, E, S	Ø.130 (Ø3.30)	#4-40 UNC (M3 X 0,5)	82° (90°)
CR2-200	0.75 (19)	0.83 (21)	0.14 (4,0)				
CR2-300	0.89 (23)	0.94 (24)	0.15 (4,3)				
CR2-400	1.07 (27)	1.06 (27)	0.16 (4,5)				

Model Number Ordering Code

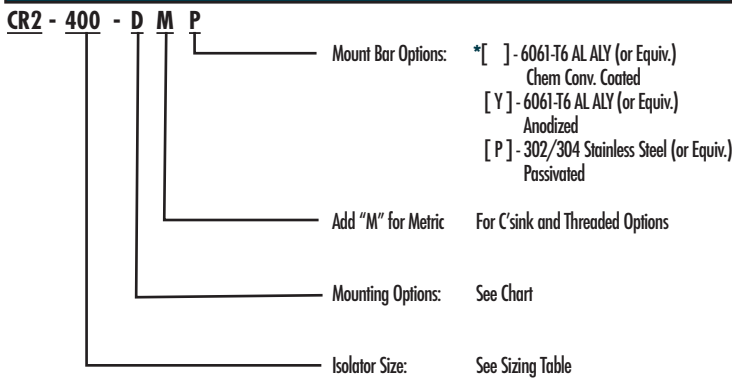

Mounting Options

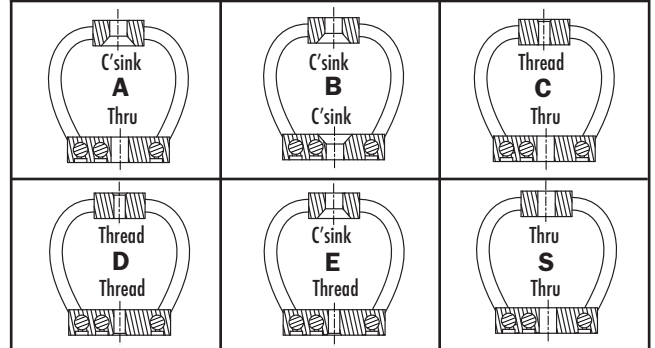

* Standard features. Any non-standard items may require longer lead times. Call for quotation.

- Maximum recommended torque for tapped aluminum bar is 10 in.-lbs. (1,2 Nm)
- Wire Rope Material: Stranded 300 series stainless steel
- Operating Temperature Range: -150°F to 500°F (-100°C to 260°C)
- U.S. Patent 6,290,217

Static Load vs. Deflection

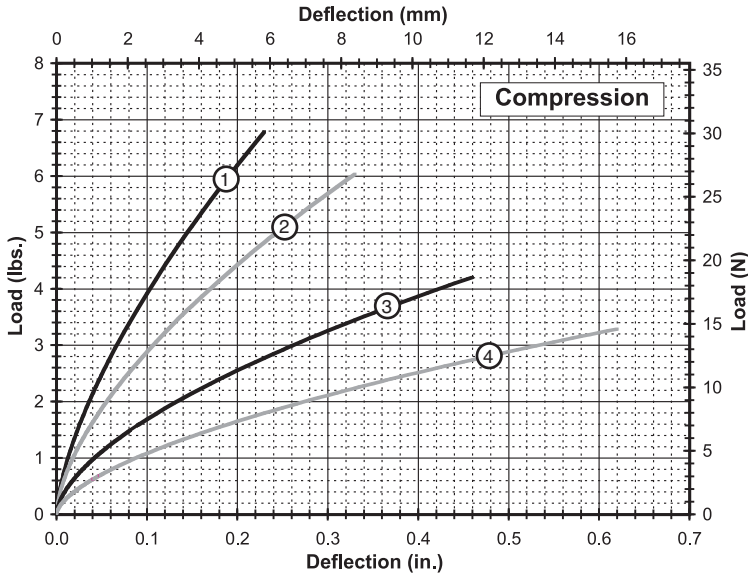

Compression

Curve	Model	Max Static Load Lbs. (N)	Max Deflection in. (mm)	Kv (vibration) Lbs./in. (kN/m)	Ks (shock) Lbs./in. (kN/m)
1	CR2-100	2.6 (12)	0.23 (5,8)	65 (11)	35 (6,1)
2	CR2-200	2.1 (9,3)	0.33 (8,4)	50 (8,8)	23 (4,0)
3	CR2-300	1.5 (6,7)	0.46 (11,7)	30 (5,3)	11 (1,9)
4	CR2-400	1.1 (4,9)	0.62 (15,7)	20 (3,5)	7 (1,2)

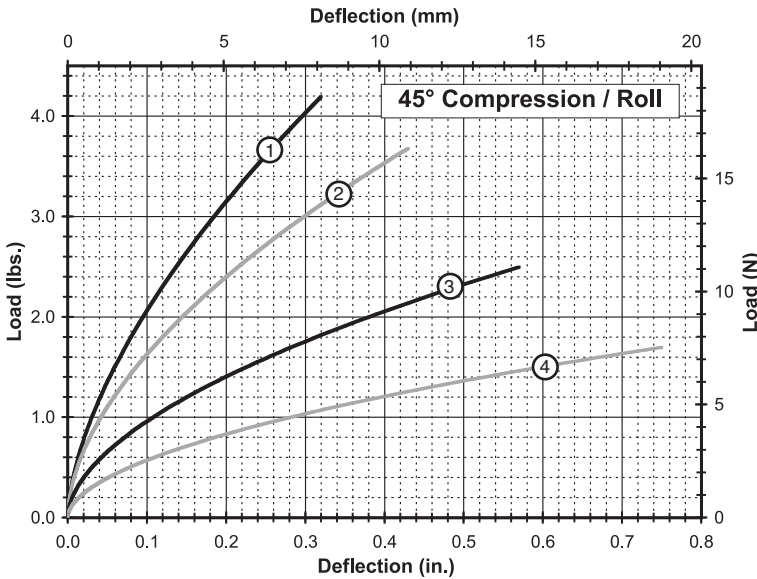

45° Compression/Roll

Curve	Model	Max Static Load Lbs. (N)	Max Deflection in. (mm)	Kv (vibration) Lbs./in. (kN/m)	Ks (shock) Lbs./in. (kN/m)
1	CR2-100	1.3 (5,8)	0.32 (8,1)	35 (6,1)	16 (2,8)
2	CR2-200	1.1 (4,9)	0.43 (10,9)	30 (5,3)	11 (1,9)
3	CR2-300	0.75 (3,3)	0.57 (14,5)	18 (3,2)	6 (1,0)
4	CR2-400	0.50 (2,2)	0.75 (19,1)	11 (1,9)	3 (0,51)

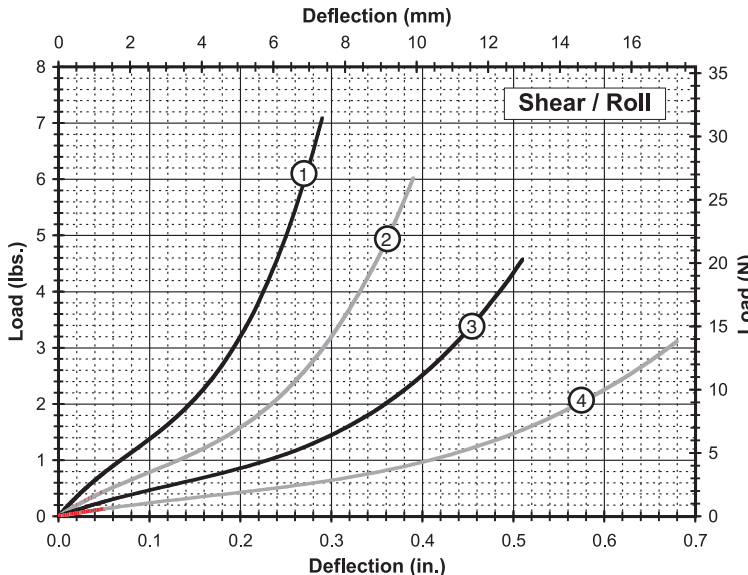

Shear/Roll

Curve	Model	Max Static Load Lbs. (N)	Max Deflection in. (mm)	Kv (vibration) Lbs./in. (kN/m)	Ks (shock) Lbs./in. (kN/m)
1	CR2-100	1.3 (5,6)	0.29 (7,4)	17 (3,0)	17 (3,0)
2	CR2-200	0.90 (4,0)	0.39 (9,9)	10 (1,8)	10 (1,8)
3	CR2-300	0.65 (2,9)	0.51 (13,0)	6 (1,1)	6 (1,1)
4	CR2-400	0.45 (2,0)	0.68 (17,3)	3 (0,53)	3 (0,53)

Note: Do not extrapolate plotted curves.

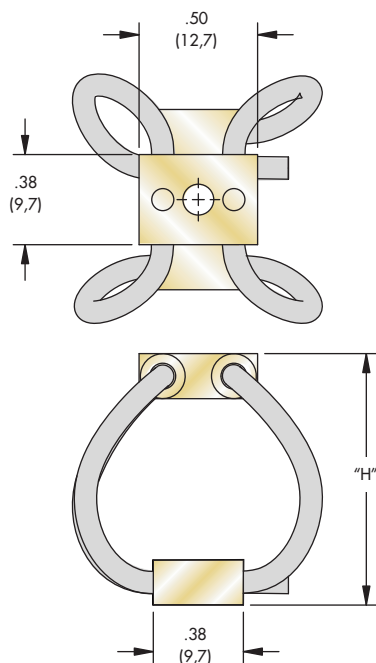

Note: Dimensions are in inches (mm)
Tolerances are $\pm .010$ ($\pm .25$ mm)

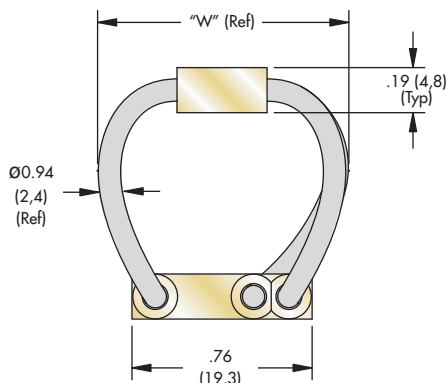

Size	Height "H" in. (mm)	Width (Ref) "W" in. (mm)	Unit Weight Lbs. (Kg)	Mounting Options	Thru Hole in. (mm)	Thread in. (mm)	C'sink Imperial (Metric)
CR3-100	0.75 (19)	0.88 (22)	0.20 (5,7)	A, B, C, D, E, S	Ø.130 (Ø3,30)	#4-40 UNC (M3 X 0,5)	82° (90°)
CR3-200	0.90 (23)	0.95 (24)	0.22 (6,2)				
CR3-300	1.06 (27)	1.06 (27)	0.24 (6,8)				
CR3-400	1.28 (33)	1.20 (30)	0.26 (7,4)				

Model Number Ordering Code

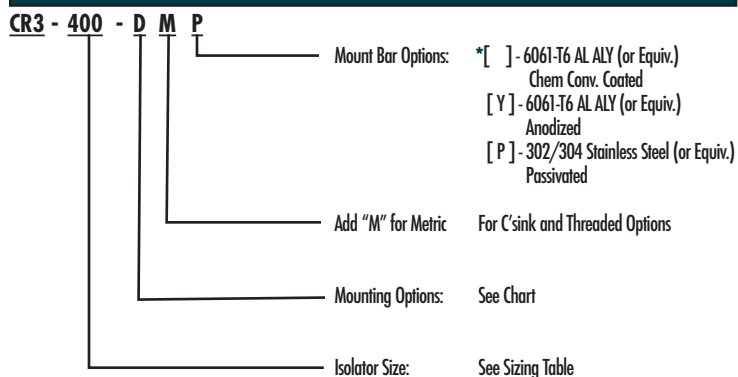

Mounting Options

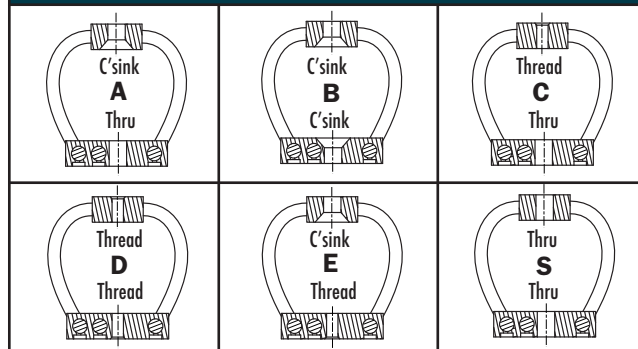

* Standard features. Any non-standard items may require longer lead times. Call for quotation.

- Maximum recommended torque for tapped aluminum bar is 13 in.-lbs. (1,5 Nm)
- Wire Rope Material: Stranded 300 series stainless steel
- Operating Temperature Range: -150°F to 500°F (-100°C to 260°C)
- U.S. Patent 6,290,217

Static Load vs. Deflection

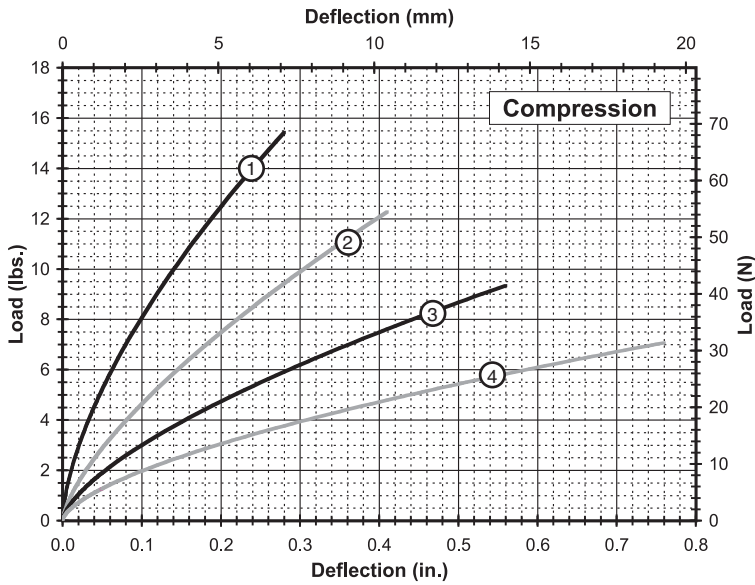

Compression

Curve	Model	Max Static Load Lbs. (N)	Max Deflection in. (mm)	Kv (vibration) Lbs./in. (kN/m)	Ks (shock) Lbs./in. (kN/m)
1	CR3-100	6.5 (29)	0.28 (7,1)	135 (24)	68 (12)
2	CR3-200	5.0 (22)	0.41 (10,4)	70 (12)	35 (6,1)
3	CR3-300	4.0 (18)	0.56 (14,2)	48 (8,4)	20 (3,5)
4	CR3-400	2.5 (11)	0.76 (19,3)	33 (5,8)	11 (1,9)

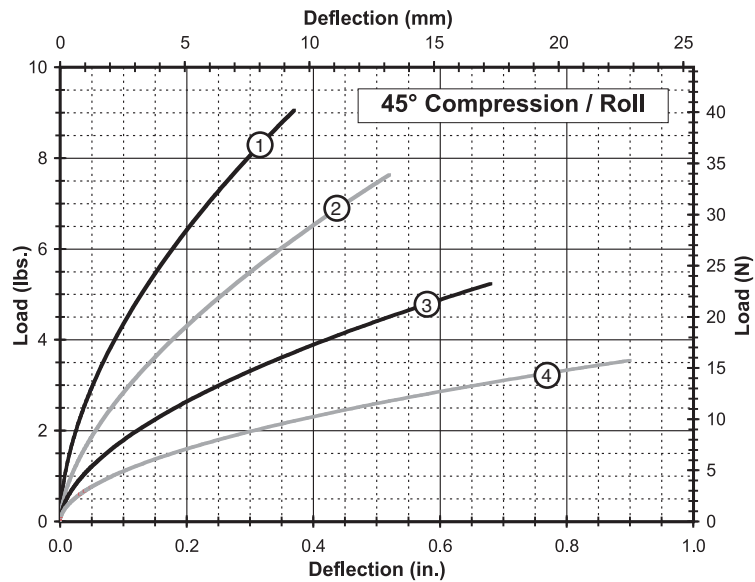

45° Compression/Roll

Curve	Model	Max Static Load Lbs. (N)	Max Deflection in. (mm)	Kv (vibration) Lbs./in. (kN/m)	Ks (shock) Lbs./in. (kN/m)
1	CR3-100	2.7 (12)	0.37 (9,4)	80 (14)	30 (5,3)
2	CR3-200	2.3 (10)	0.52 (13,2)	50 (8,8)	18 (3,2)
3	CR3-300	1.5 (6,7)	0.68 (17,3)	33 (5,8)	10 (1,8)
4	CR3-400	1.0 (4,4)	0.90 (22,9)	20 (3,5)	5 (0,91)

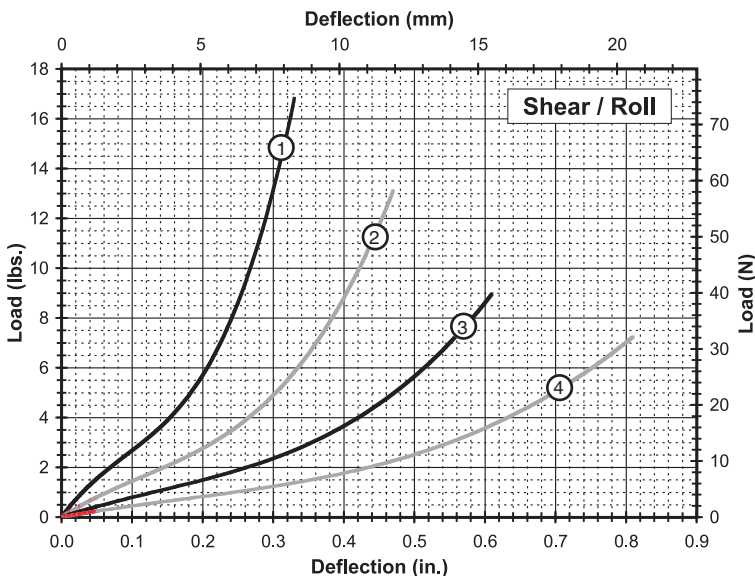

Shear/Roll

Curve	Model	Max Static Load Lbs. (N)	Max Deflection in. (mm)	Kv (vibration) Lbs./in. (kN/m)	Ks (shock) Lbs./in. (kN/m)
1	CR3-100	2.7 (12)	0.33 (8,4)	35 (6,1)	35 (6,1)
2	CR3-200	1.9 (8,5)	0.47 (11,9)	20 (3,5)	20 (3,5)
3	CR3-300	1.4 (6,2)	0.61 (15,5)	10 (1,8)	10 (1,8)
4	CR3-400	1.0 (4,4)	0.81 (20,6)	6 (1,1)	6 (1,1)

Note: Do not extrapolate plotted curves.

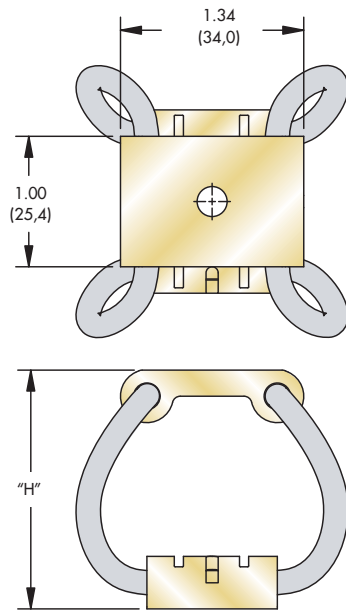

Note: Dimensions are in inches (mm)
Tolerances are $\pm .010$ ($\pm .25$ mm)

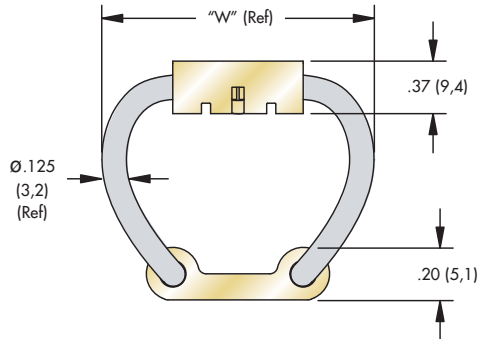

Size	Height "H" in. (mm)	Width (Ref) "W" in. (mm)	Unit Weight Lbs. (Kg)	Mounting Options	Thru Hole in. (mm)	Thread in. (mm)	C'sink Imperial (Metric)
CR4-100	1.66 (42)	1.87 (47)	1.4 (40)	A, B, C, D, E, S	Ø.230 (Ø7,00)	#10-32 UNF (M6 X 1,0)	82° (90°)
CR4-200	2.10 (53)	2.12 (54)	1.4 (40)				
CR4-300	2.37 (60)	2.34 (59)	1.5 (43)				
CR4-400	2.96 (75)	2.67 (68)	1.7 (48)				

Model Number Ordering Code

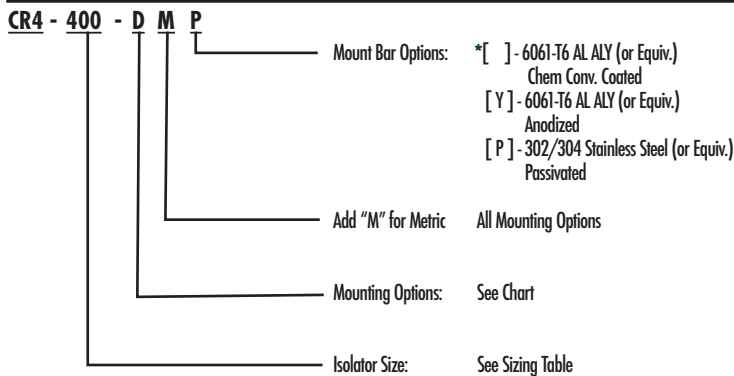

Mounting Options

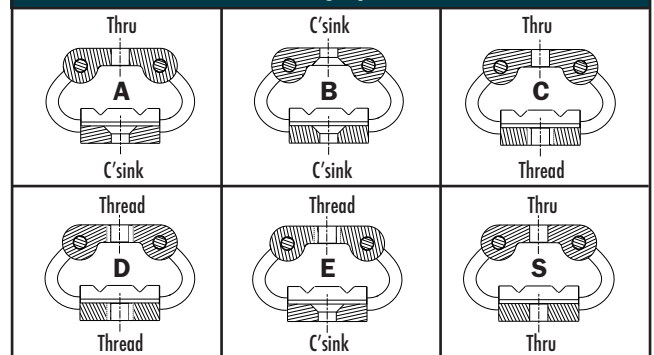

- Maximum recommended torque for tapped aluminum bar is 40 in.-lbs. (7,5 Nm)
- Wire Rope Material: Stranded 300 series stainless steel
- Operating Temperature Range: -150°F to 500°F (-100°C to 260°C)
- U.S. Patent 6,244,579

* Standard features. Any non-standard items may require longer lead times. Call for quotation.

Static Load vs. Deflection

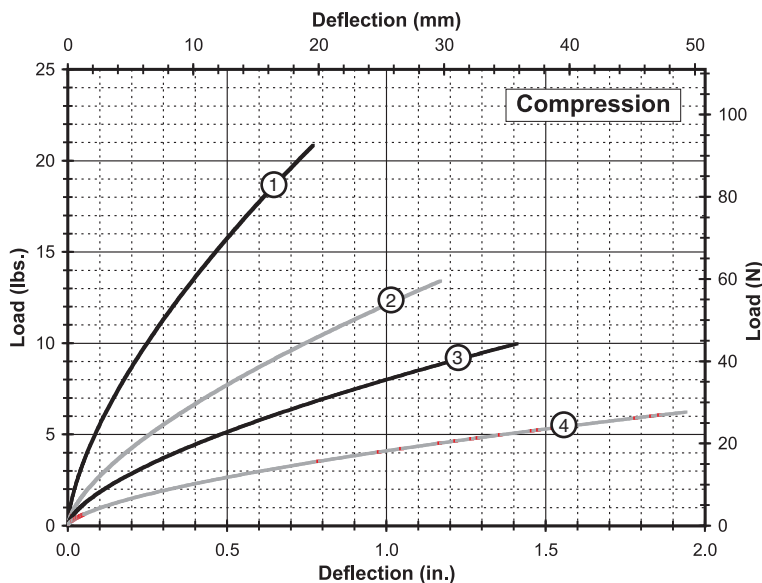

Compression

Curve	Model	Max Static Load Lbs. (N)	Max Deflection in. (mm)	Kv (vibration) Lbs./in. (kN/m)	Ks (shock) Lbs./in. (kN/m)
1	CR4-100	5.5 (24)	0.77 (19,6)	70 (12)	33 (5,8)
2	CR4-200	4.0 (18)	1.17 (29,7)	35 (6,0)	14 (2,5)
3	CR4-300	3.0 (13)	1.41 (35,8)	25 (4,4)	9 (1,6)
4	CR4-400	1.5 (6,7)	1.94 (49,3)	12 (2,2)	4 (0,70)

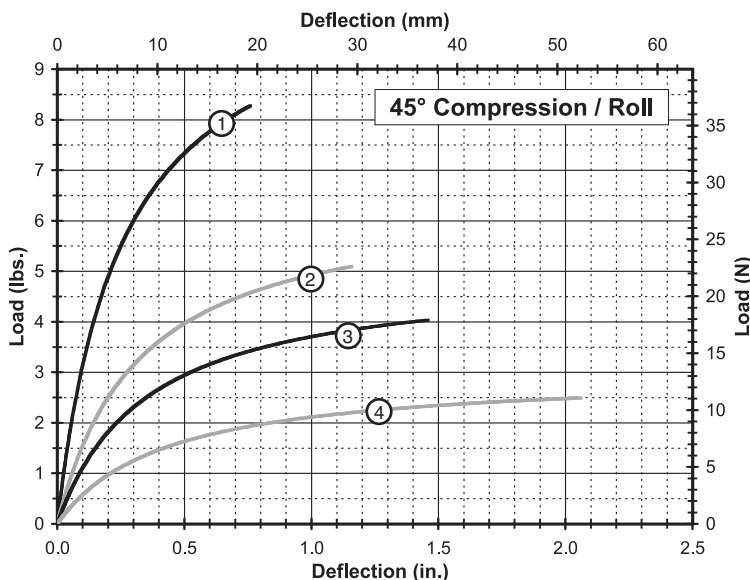

45° Compression/Roll

Curve	Model	Max Static Load Lbs. (N)	Max Deflection in. (mm)	Kv (vibration) Lbs./in. (kN/m)	Ks (shock) Lbs./in. (kN/m)
1	CR4-100	2.5 (11)	0.76 (19,3)	37 (6,4)	16 (2,8)
2	CR4-200	1.5 (6,7)	1.16 (29,5)	18 (3,1)	6 (1,1)
3	CR4-300	1.2 (5,3)	1.46 (37,1)	13 (2,2)	4 (0,70)
4	CR4-400	0.80 (3,6)	2.06 (52,3)	6 (1,1)	2 (0,35)

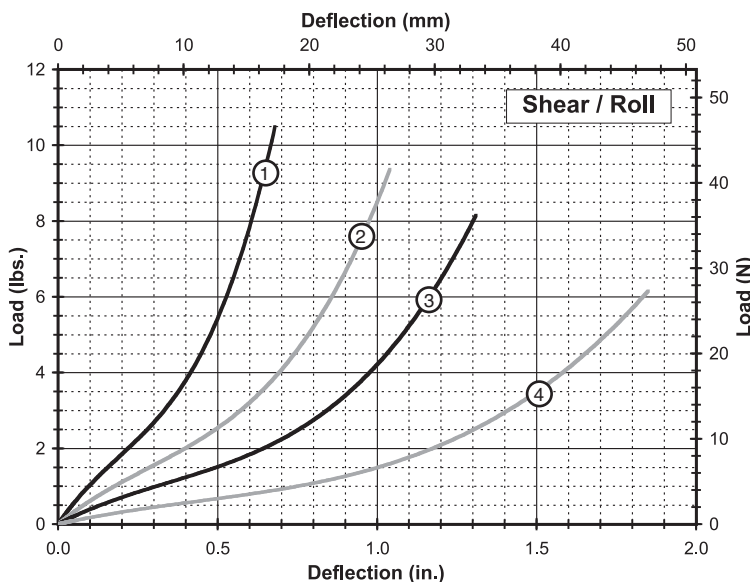

Shear/Roll

Curve	Model	Max Static Load Lbs. (N)	Max Deflection in. (mm)	Kv (vibration) Lbs./in. (kN/m)	Ks (shock) Lbs./in. (kN/m)
1	CR4-100	1.9 (8,5)	0.68 (17,3)	11 (1,9)	11 (1,9)
2	CR4-200	1.6 (7,1)	1.04 (26,4)	6 (1,1)	6 (1,1)
3	CR4-300	1.2 (5,3)	1.31 (33,3)	4 (0,70)	4 (0,70)
4	CR4-400	0.75 (3,3)	1.85 (47,0)	2 (0,35)	2 (0,35)

Note: Do not extrapolate plotted curves.

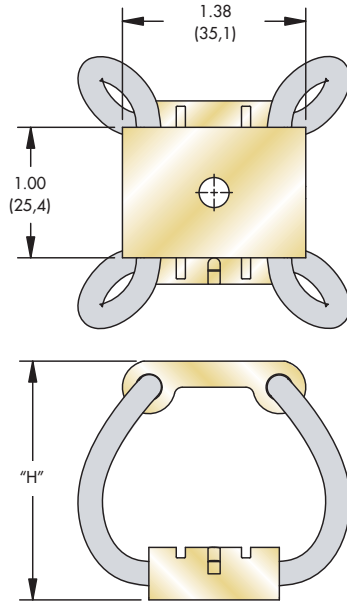

Note: Dimensions are in inches (mm)
Tolerances are $\pm .010$ ($\pm .25$ mm)

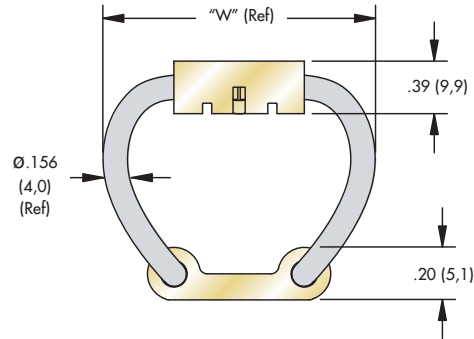

Size	Height "H" in. (mm)	Width (Ref) "W" in. (mm)	Unit Weight Lbs. (Kg)	Mounting Options	Thru Hole in. (mm)	Thread in. (mm)	C'sink Imperial (Metric)
CR5-100	1.60 (41)	1.89 (48)	1.6 (45)	A, B, C, D, E, S	Ø.230 (Ø7,00)	#10-32 UNF (M6 X 1,0)	82° (90°)
CR5-200	2.09 (53)	2.13 (54)	1.7 (48)				
CR5-300	2.36 (60)	2.32 (59)	1.8 (51)				
CR5-400	2.99 (76)	2.64 (67)	2.0 (57)				

Model Number Ordering Code

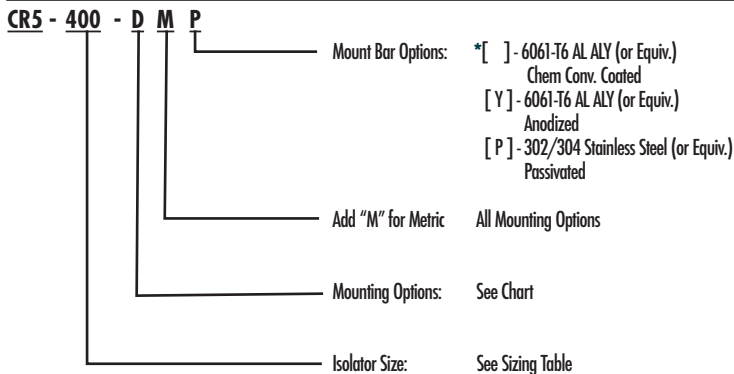

Mounting Options

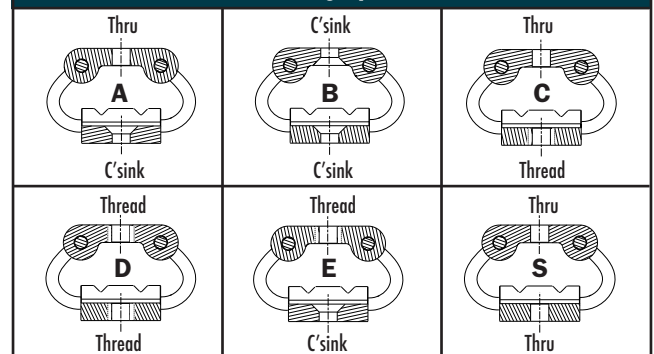

* Standard features. Any non-standard items may require longer lead times. Call for quotation.

- Maximum recommended torque for tapped aluminum bar is 40 in.-lbs. (7,5 Nm)
- Wire Rope Material: Stranded 300 series stainless steel
- Operating Temperature Range: -150°F to 500°F (-100°C to 260°C)
- U.S. Patent 6,244,579

Static Load vs. Deflection

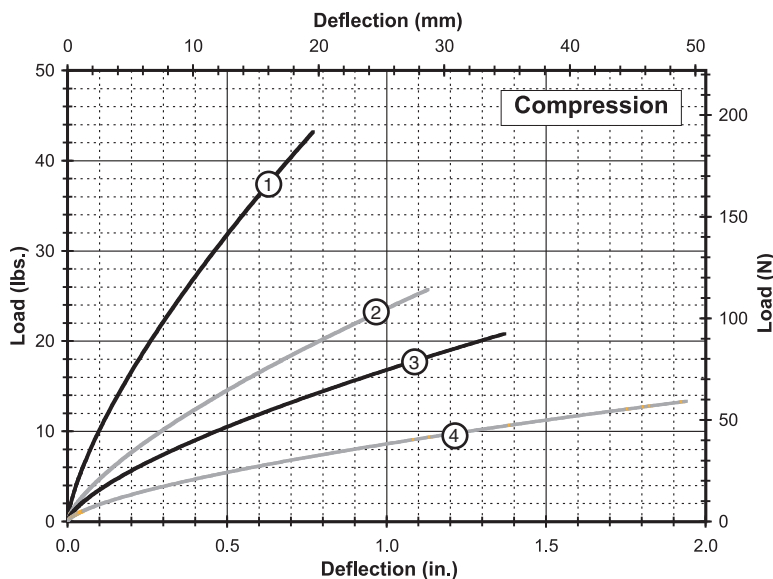

Compression

Curve	Model	Max Static Load Lbs. (N)	Max Deflection in. (mm)	Kv (vibration) Lbs./in. (kN/m)	Ks (shock) Lbs./in. (kN/m)
1	CR5-100	18 (80)	0.77 (19,6)	125 (22)	65 (11)
2	CR5-200	8.5 (38)	1.13 (28,7)	60 (11)	25 (4,4)
3	CR5-300	6.0 (27)	1.37 (34,8)	45 (7,9)	18 (3,2)
4	CR5-400	3.5 (16)	1.94 (49,3)	25 (4,4)	8 (1,4)

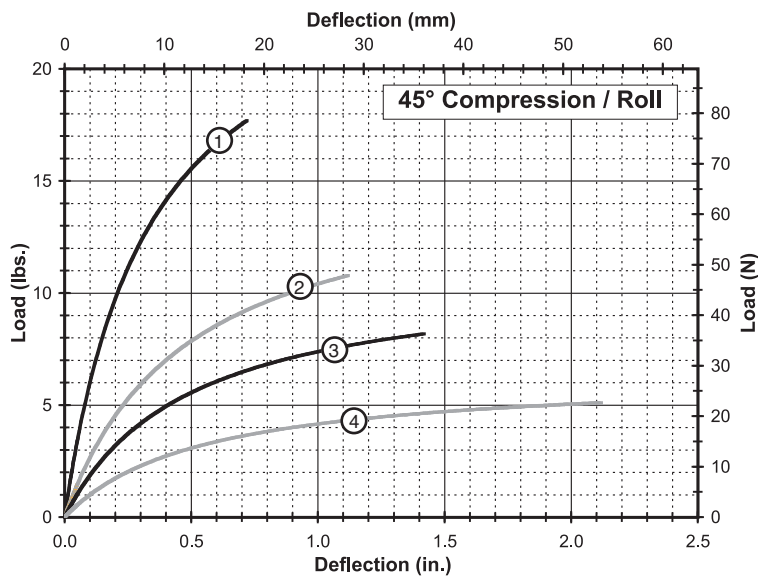

45° Compression/Roll

Curve	Model	Max Static Load Lbs. (N)	Max Deflection in. (mm)	Kv (vibration) Lbs./in. (kN/m)	Ks (shock) Lbs./in. (kN/m)
1	CR5-100	5.5 (24)	0.72 (18,3)	70 (12)	35 (6,1)
2	CR5-200	3.0 (13)	1.12 (28,4)	30 (5,3)	13 (2,3)
3	CR5-300	2.5 (11)	1.42 (36,1)	20 (3,6)	8 (1,4)
4	CR5-400	1.5 (6,7)	2.12 (53,8)	11 (1,9)	4 (0,70)

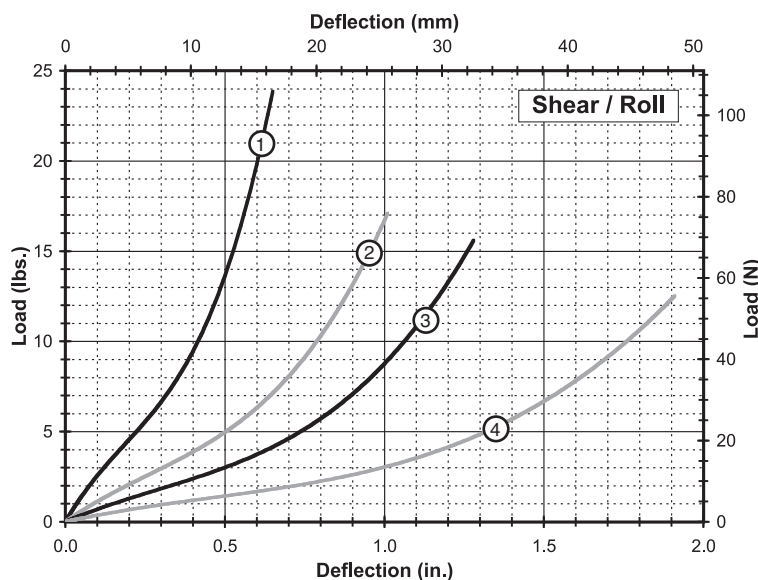

Shear/Roll

Curve	Model	Max Static Load Lbs. (N)	Max Deflection in. (mm)	Kv (vibration) Lbs./in. (kN/m)	Ks (shock) Lbs./in. (kN/m)
1	CR5-100	4.5 (20)	0.65 (16,5)	25 (4,4)	25 (4,4)
2	CR5-200	3.0 (13)	1.01 (25,7)	12 (2,1)	12 (2,1)
3	CR5-300	2.5 (11)	1.28 (32,5)	8 (1,4)	8 (1,4)
4	CR5-400	1.5 (6,7)	1.91 (48,5)	4 (0,70)	4 (0,70)

Note: Do not extrapolate plotted curves.

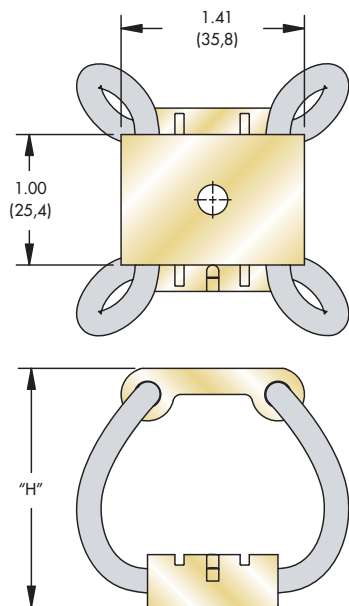

Note: Dimensions are in inches (mm)
Tolerances are ± .010 (± .25mm)

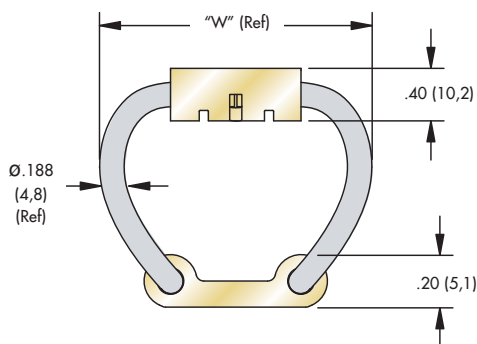

Size	Height "H" in. (mm)	Width (Ref) "W" in. (mm)	Unit Weight Lbs. (Kg)	Mounting Options	Thru Hole in. (mm)	Thread in. (mm)	C'sink Imperial (Metric)
CR6-100	1.83 (47)	2.11 (54)	2.0 (57)	A, B, C, D, E, S	Ø.230 (Ø7,00)	#10-32 UNF (M6 X 1,0)	82° (90°)
CR6-200	2.15 (55)	2.31 (59)	2.2 (62)				
CR6-300	2.51 (64)	2.50 (64)	2.3 (65)				
CR6-400	3.09 (79)	2.86 (73)	2.6 (74)				

Model Number Ordering Code

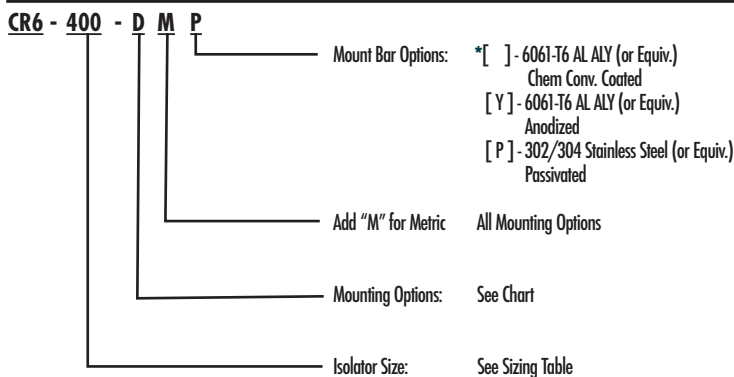

Mounting Options

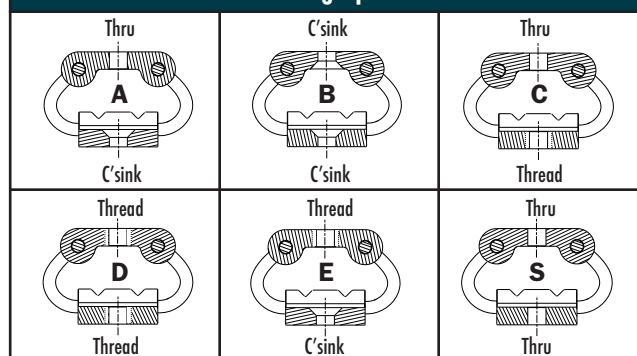

* Standard features. Any non-standard items may require longer lead times. Call for quotation.

- Maximum recommended torque for tapped aluminum bar is 40 in.-lbs. (7,5 Nm)
- Wire Rope Material: Stranded 300 series stainless steel
- Operating Temperature Range: -150°F to 500°F (-100°C to 260°C)
- U.S. Patent 6,244,579

Static Load vs. Deflection

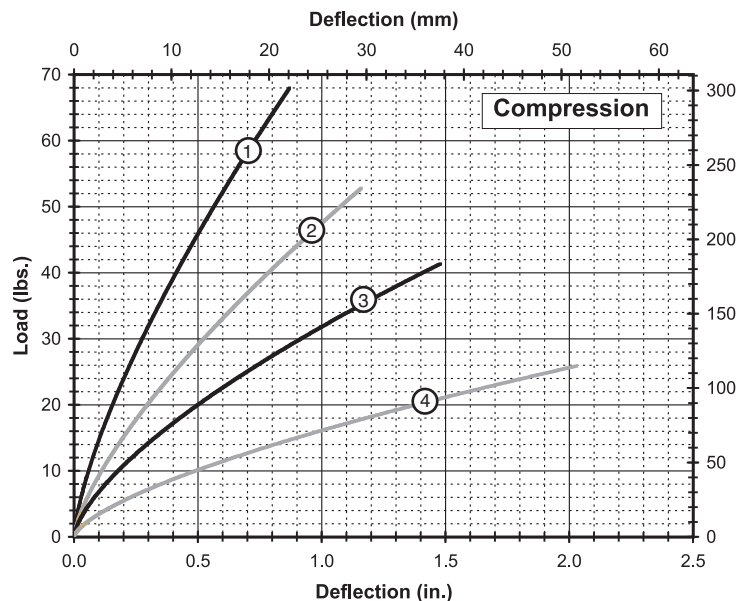

Compression

Curve	Model	Max Static Load Lbs. (N)	Max Deflection in. (mm)	Kv (vibration) Lbs./in. (kN/m)	Ks (shock) Lbs./in. (kN/m)
1	CR6-100	32 (142)	0.87 (22,1)	180 (32)	90 (16)
2	CR6-200	21 (93)	1.16 (29,5)	115 (20)	55 (9,6)
3	CR6-300	15 (67)	1.48 (37,6)	85 (15)	30 (5,3)
4	CR6-400	8.0 (36)	2.03 (51,6)	45 (7,9)	15 (2,6)

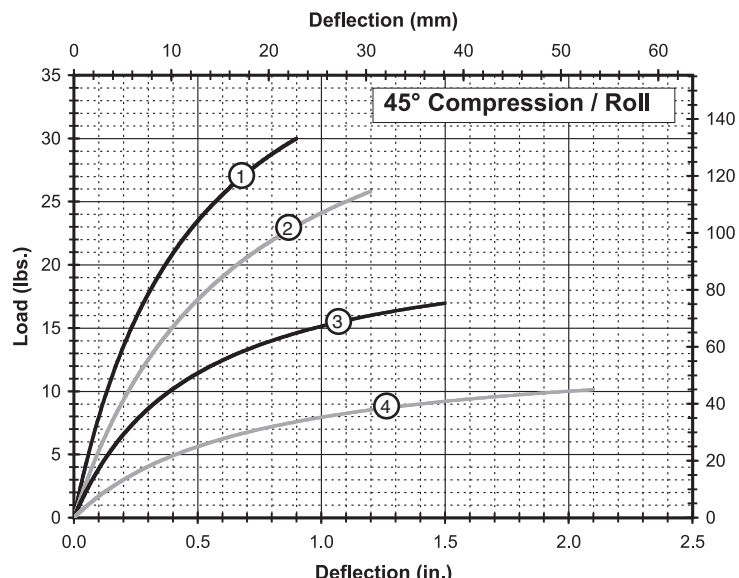

45° Compression/Roll

Curve	Model	Max Static Load Lbs. (N)	Max Deflection in. (mm)	Kv (vibration) Lbs./in. (kN/m)	Ks (shock) Lbs./in. (kN/m)
1	CR6-100	9.0 (40)	0.9 (22,9)	90 (16)	45 (7,9)
2	CR6-200	7.5 (33)	1.2 (30,5)	55 (9,6)	30 (5,3)
3	CR6-300	5.0 (22)	1.5 (38,1)	45 (7,9)	16 (2,8)
4	CR6-400	3.0 (13)	2.1 (53,3)	20 (3,5)	7 (1,2)

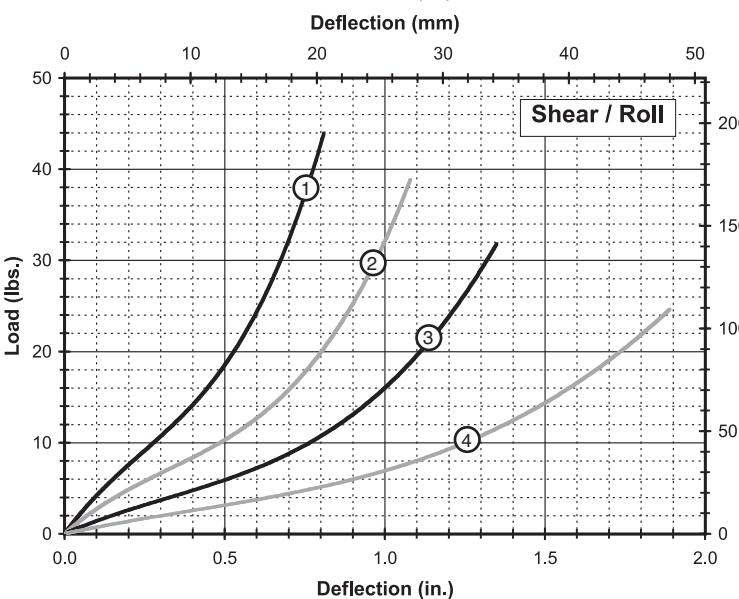

Shear/Roll

Curve	Model	Max Static Load Lbs. (N)	Max Deflection in. (mm)	Kv (vibration) Lbs./in. (kN/m)	Ks (shock) Lbs./in. (kN/m)
1	CR6-100	9.0 (40)	0.81 (20,6)	45 (7,9)	45 (7,9)
2	CR6-200	7.0 (31)	1.08 (27,4)	25 (4,4)	25 (4,4)
3	CR6-300	5.0 (22)	1.35 (34,3)	15 (2,6)	15 (2,6)
4	CR6-400	3.5 (16)	1.89 (48,0)	9 (1,6)	9 (1,6)

Note: Do not extrapolate plotted curves.



The HERM isolator incorporates the use of a traditional Enidine helical wire rope isolator encased in a proprietary elastomeric compound. The stainless steel cable of the mount provides for a rugged construction, while the elastomer provides additional damping and stiffness. This unique design results in a fail safe mount with a higher stiffness and energy absorption capacity.

The mount is readily scalable and performance easily tuned by varying the wire diameter, loop size, number of loops and elastomeric properties. The HERM isolator has proven particularly strong in low natural frequency "soft deck" applications of 12-16 Hz, reducing output G's to below 15G's. Its sealed nature of construction also provides for easy NBC washdown. Since the mounting size of the HERM isolator is virtually identical to that of standard wire rope isolators used in many shipboard applications, equipment upgrades are both simple and seamless with drop-in replacement capability.

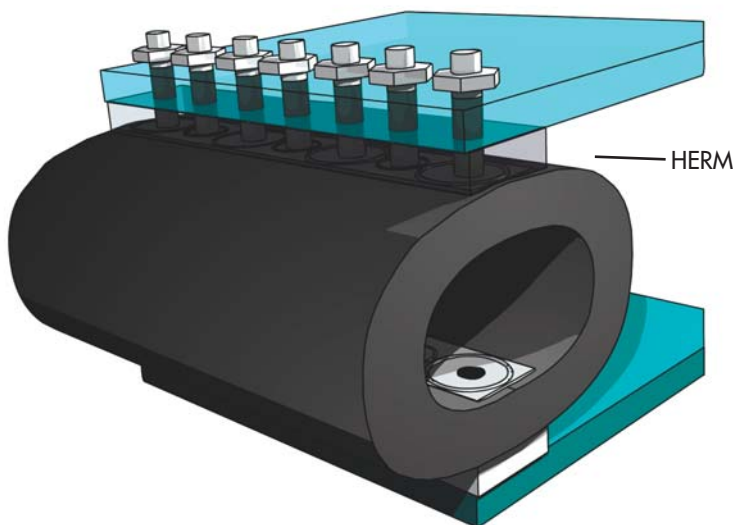
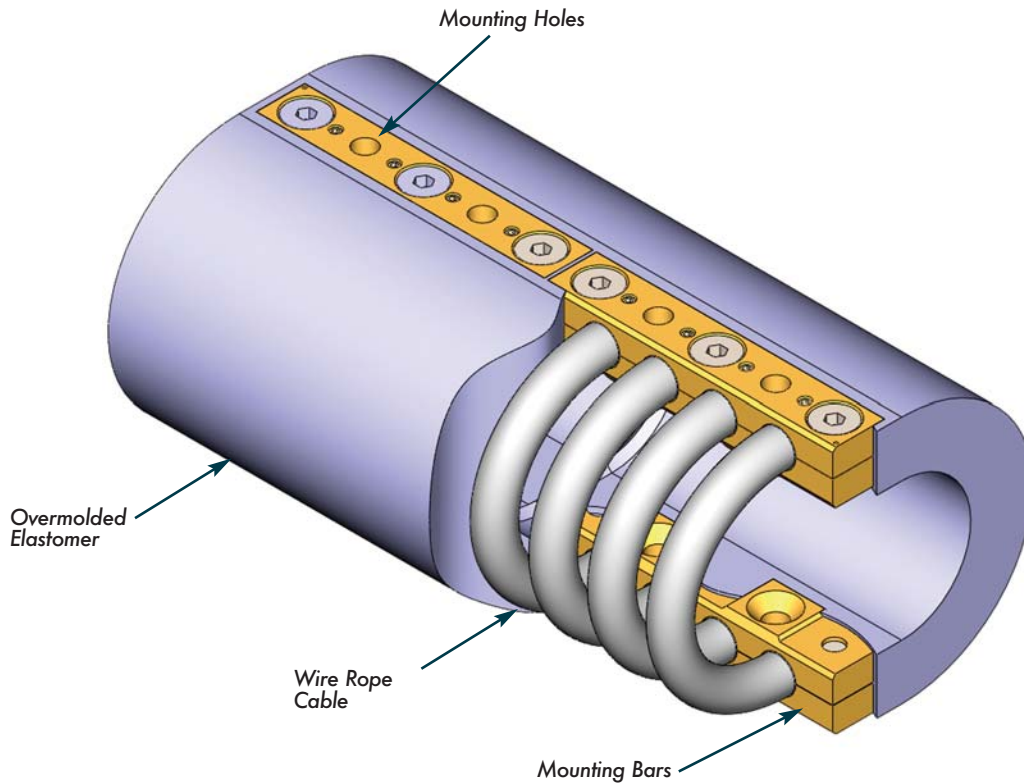

HERM Features:

- Lowest profile design for a 14 Hz deck solution
- A variety of material combinations available
- Mounting identical to traditional Wire Rope Isolators
- Readily "tunable" to meet a wide range of natural frequencies
- Greater load carrying capability

HERM Benefits:

- Easy retrofit on fielded equipment
- Fewer mounts required to support a given load
- Smaller "footprint" than other mounts
- Compatible with NBC wash down requirements
- Improved noise attenuation compared to standard Wire Rope Isolators

Materials and Finishes:

Standard: Elastomer: Proprietary Enidine Compound
 Wire Rope: 302/304 Stainless Steel
 Mount Bars: 6061-T6 Aluminum, Chemical Conversion Coated per MIL-C-5541, Class 1A
 Hardware: Alloy Steel per ASTM F835, Zinc Plated (HR16, HR20, HR28 and HR40)

Optional: Mount Bars: 6061-T6 Aluminum, Anodized per MIL-A-8625, Type II, Class 1
 302/304 Stainless Steel per ASTM A276, Passivated
 Hardware: 302/304 Stainless Steel (when stainless steel bars are specified)

Special: Consult Enidine

Isolator Options:

Mounting: Enidine offers various mounting combinations of thru-hole, countersunk, and threaded bars depending upon the HERM model selected.
 Consult Enidine if a preferred mounting configuration is not listed.

Performance:

Stiffness (Kv or Ks):

HERM's exhibit non-linear stiffness behavior. Small deflections, usually associated with vibration isolation, will have a different spring rate than larger shock deflections. Enidine publishes typical vibration stiffness values (Kv), and average shock stiffness values (Ks) within the catalog. These values can be used with the provided equations listed on Page 54 to predict system performance.

Isolator Axes:

HERM are multi-axis isolators. The diagram below includes load axis definitions and deflection considerations.

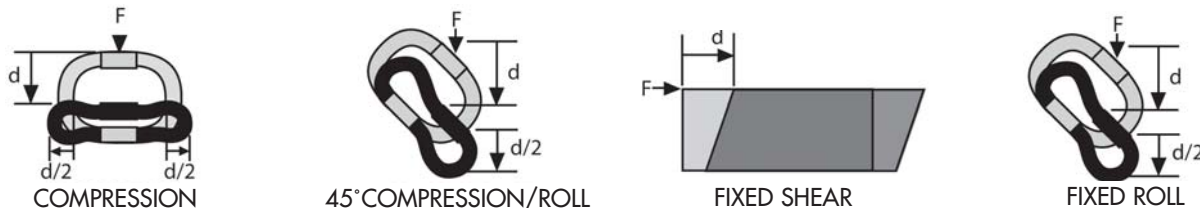

Damping: Typically 15-25%, depending on size and input level. For specific damping considerations, please consult Enidine.

Mounting Orientation:

The diagrams below illustrate typical mounting orientations.

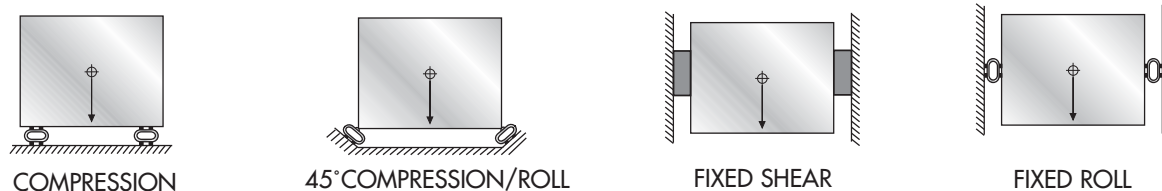

Stabilizers:

Stabilizers are used to control deflections of tall supported masses. Stabilizers are typically recommended when the height equals 2-times the width or depth dimension.

APPLICATION WORKSHEET - INPUTS IMPERIAL/METRIC		IMPERIAL	METRIC
PART I: SYSTEM DATA:			
1. Total Supported Load (W _T):	W _T = _____ lbs. W _T = _____ Kg x 9.81 = _____ N		
2. Number of Isolators (n):	n = _____		
3. Static Load per Isolator (W):	W = $\frac{W_T}{n}$	W = _____ lbs.*	W = _____ N*
* Assumes a central CG			
4. Load Axis: Compression Shear or Roll 45° Compression/Roll		Load Axis	Load Axis
PART II: VIBRATION SIZING:			
1. Input Excitation Frequency	(f _i) = _____ Hz (= $\frac{rpm}{60}$)		
2. System Response Natural Frequency for 80% isolation:	f _n = $\frac{f_i}{3.0}$ = _____ Hz		
3. Maximum Isolator Vibration Stiffness: (K _v)	K _v = $\frac{W (2\pi f_n)^2}{g}$ g = 386 in./sec ² or 9.81 m/sec ²	K _v = _____ lbs./in.	K _v = _____ N/m
4. Select an isolator by comparing calculated values with technical data for the desired load axis provided in tables for each isolator. a.) Calculated "W" must be less than the isolator's max static load and b.) Isolator's vibration stiffness must be less than the calculated maximum K _v			
PART III: SHOCK SIZING:			
1. Maximum Allowable Transmitted Acceleration:	A _T = _____ G's		
2. Shock Input Velocity:	V = _____ in./sec. V = _____ m/sec.		
Free Fall Impact:	V = $\sqrt{2gh}$ g = 386 in./sec. ² or 9.81 m/sec. ² h = Drop Height (in. or m)		
3. Min. Isolator Response Deflection:	D _{min} = $\frac{V^2}{g(A_T)}$	D _{min} = _____ in.	D _{min} = _____ m
4. Maximum Isolator Shock Stiffness:	K _s = $\frac{W(V/D_{min})^2}{g}$	K _s = _____ lbs./in.	K _s = _____ N/m
5. Select an isolator by comparing calculated values with technical data for the desired load axis provided in tables for each isolator. a.) Calculated "W" must be less than the isolator's max static load and b.) Calculated D _{min} must be less than the isolator's max deflection Note: Metric deflections are calculated in meters (m) and technical data is in millimeters (mm). and c.) Isolator's shock stiffness must be less than calculated maximum "K _s "			
6. Check actual deflection using "K _s " from technical data to ensure that the isolator's max deflection is not exceeded.	D _{actual} = $\sqrt{\frac{V}{K_s(Isolator)g}}$	D _{actual} = _____ in.	D _{actual} = _____ m
7. If isolator's max deflection is exceeded, select another isolator and repeat steps 5 and 6.			

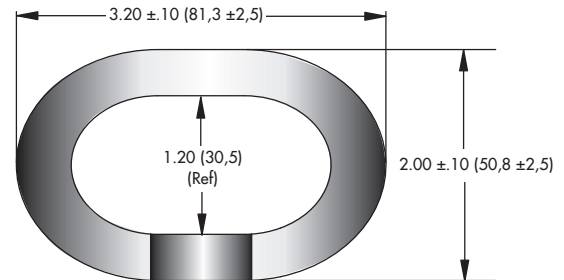
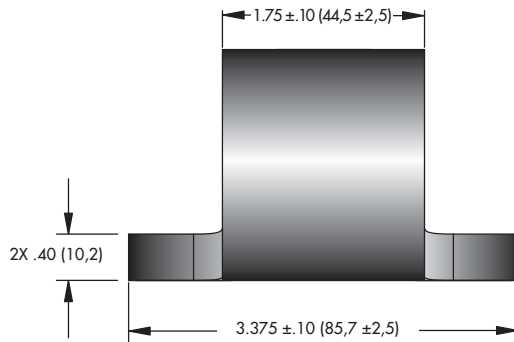
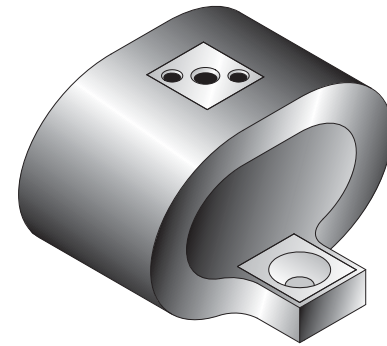
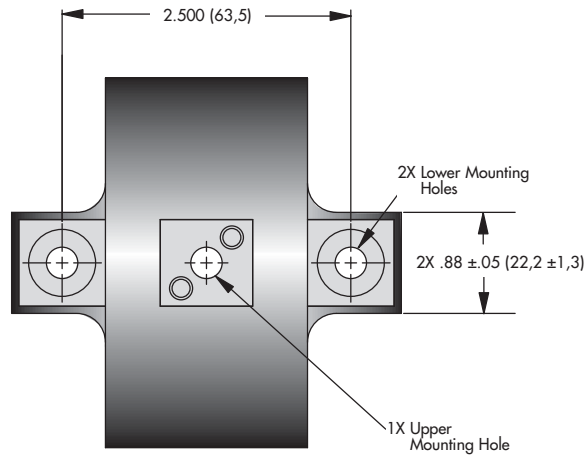

Note: Dimensions are in inches (mm) Tolerances are ± .010 (± .25mm)

Size	Unit Weight lbs. (Kg)	Mounting Options	Thru Hole in. (mm)	Thread in. (mm)	C'sink Imperial (Metric)
HR6-600	0.4 (0,2)	B, D, E, F	Ø.272 (Ø6,9)	#1/4-20 UNC (M6 X 1,0)	82° (90°)
HR6-400	0.4 (0,2)				
HR6-200	0.4 (0,2)				

Model Number Ordering Code

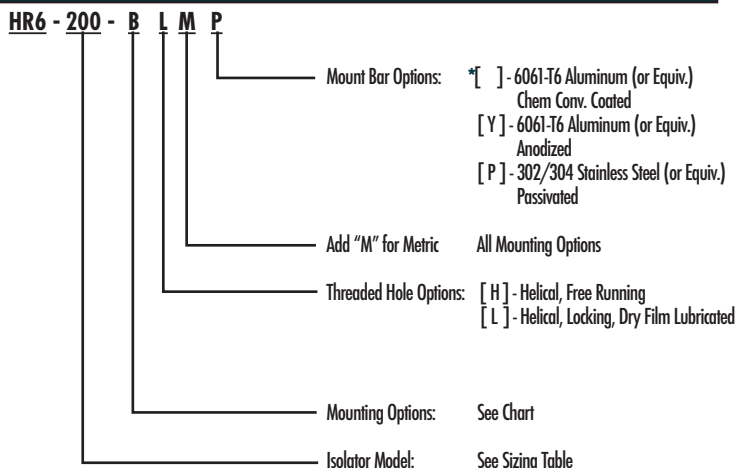

Mounting Options

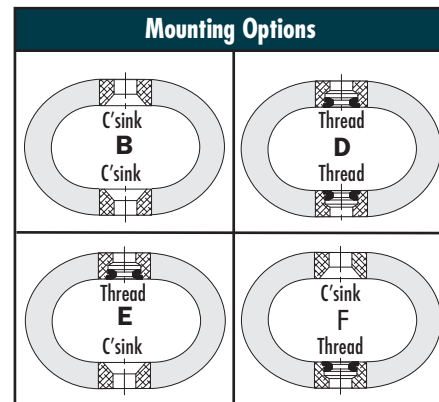

• Meets environmental requirements of MIL-M-17185A

* Standard features. Any non-standard items may require longer lead times. Call for quotation.

Technical Data

Static Load vs. Deflection

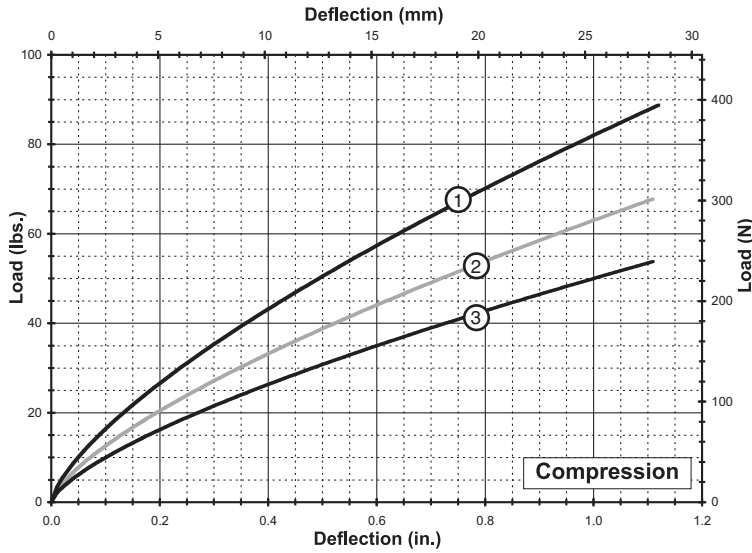

Compression

Curve	Model	Max Static Load Lbs. (N)	Max Deflection in. (mm)	Kv (vibration) Lbs./in. (kN/m)	Ks (shock) Lbs./in. (kN/m)
1	HR6-600	24 (107)	1.12 (28,4)	215 (38)	140 (25)
2	HR6-400	18 (80)	1.12 (28,4)	165 (29)	110 (19)
3	HR6-200	14 (62)	1.12 (28,4)	130 (23)	85 (15)

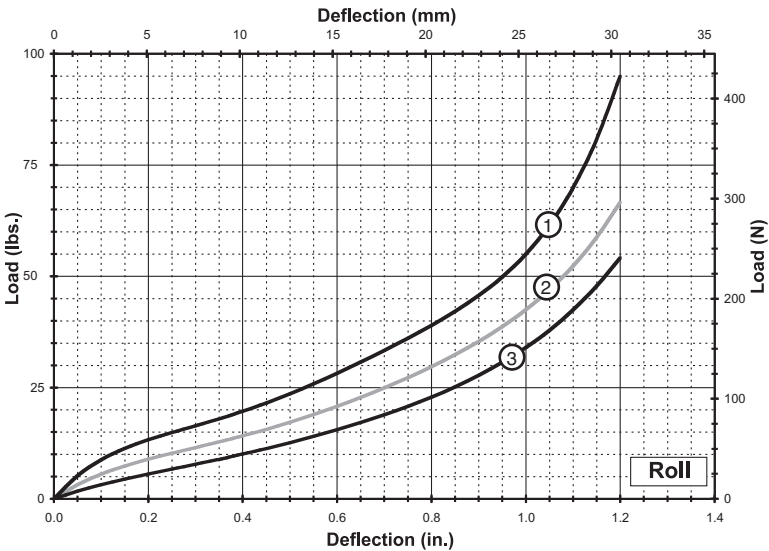

Roll

Curve	Model	Max Static Load Lbs. (N)	Max Deflection in. (mm)	Kv (vibration) Lbs./in. (kN/m)	Ks (shock) Lbs./in. (kN/m)
1	HR6-600	18 (80)	1.20 (30,5)	115 (20)	83 (15)
2	HR6-400	13 (58)	1.20 (30,5)	73 (13)	63 (11)
3	HR6-200	9 (40)	1.20 (30,5)	40 (7)	48 (9)

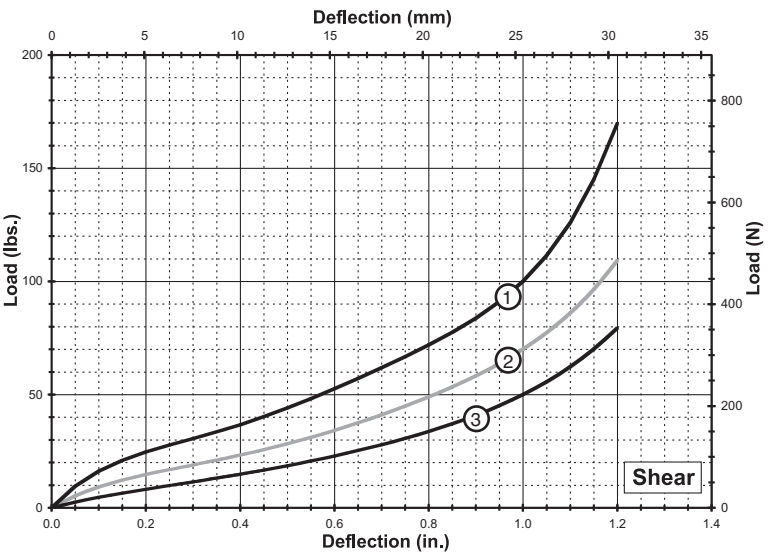

Shear

Curve	Model	Max Static Load Lbs. (N)	Max Deflection in. (mm)	Kv (vibration) Lbs./in. (kN/m)	Ks (shock) Lbs./in. (kN/m)
1	HR6-600	34 (151)	1.20 (30,5)	210 (37)	150 (26)
2	HR6-400	20 (89)	1.20 (30,5)	120 (21)	100 (18)
3	HR6-200	13 (58)	1.20 (30,5)	60 (11)	70 (12)

Note: Do not extrapolate plotted curves.

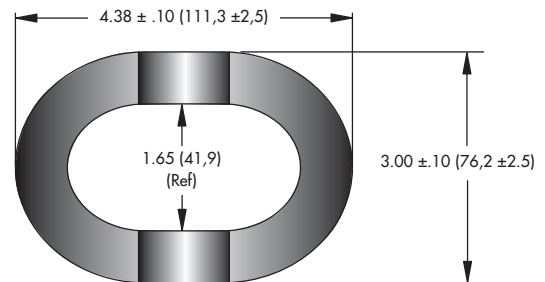
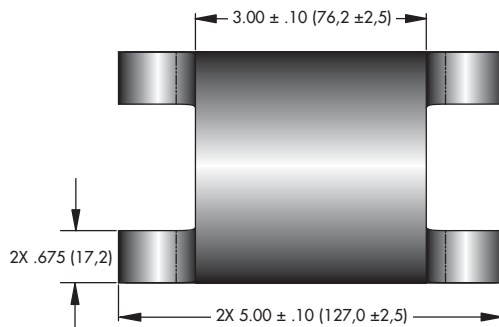
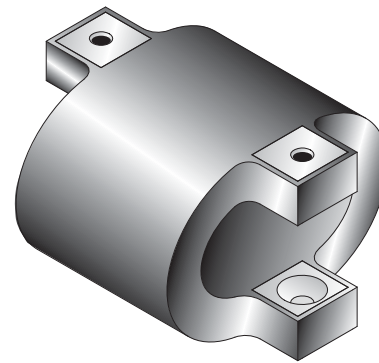
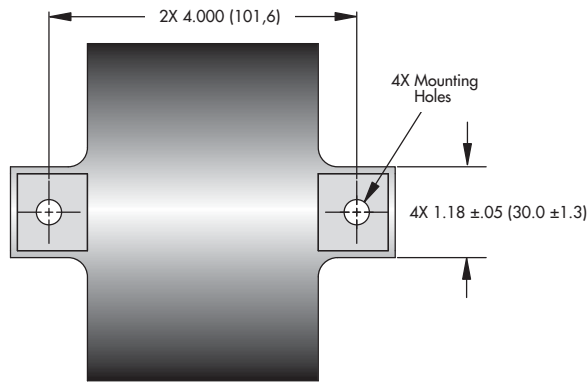

Note: Dimensions are in inches (mm) Tolerances are ± .010 (± .25mm)

Size	Unit Weight lbs. (Kg)	Mounting Options	Thru Hole in. (mm)	Thread in. (mm)	C'sink Imperial (Metric)
HR12-600	1.8 (0,8)	B, D, E	Ø.328 ±.005 (Ø9,0 ±0,13)	#5/16-18 UNC (M8 X 1,25)	82° (90°)
HR12-400	1.8 (0,8)				
HR12-200	1.8 (0,8)				

Model Number Ordering Code

HR12-200 - B L M P

- Mount Bar Options:
 - *[] - 6061-T6 Aluminum (or Equiv.) Chem Conv. Coated
 - [Y] - 6061-T6 Aluminum (or Equiv.) Anodized
 - [P] - 302/304 Stainless Steel (or Equiv.) Passivated
- Add "M" for Metric: All Mounting Options
- Threaded Hole Options:
 - [H] - Helical, Free Running
 - [L] - Helical, Locking, Dry Film Lubricated
- Mounting Options: See Chart
- Isolator Model: See Sizing Table

Mounting Options

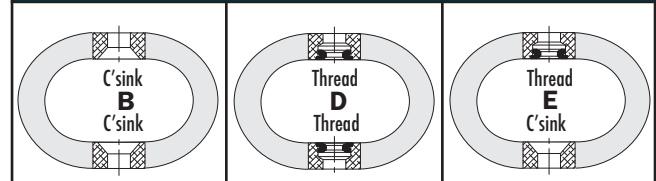

• Meets environmental requirements of MIL-M-17185A

* Standard features. Any non-standard items may require longer lead times. Call for quotation.

Static Load vs. Deflection

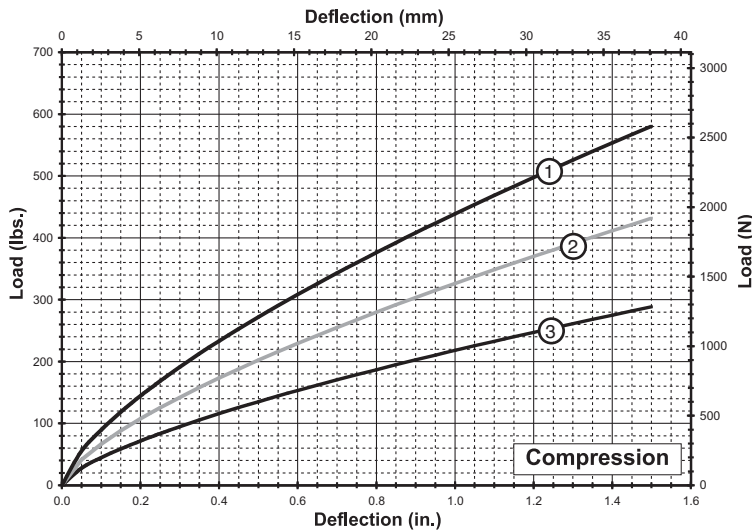

Compression

Curve	Model	Max Static Load Lbs. (N)	Max Deflection in. (mm)	Kv (vibration) Lbs./in. (kN/m)	Ks (shock) Lbs./in. (kN/m)
1	HR12-600	155 (689)	1.50 (38,1)	1,165 (204)	690 (121)
2	HR12-400	115 (512)	1.50 (38,1)	865 (151)	510 (89)
3	HR12-200	80 (356)	1.50 (38,1)	580 (102)	340 (60)

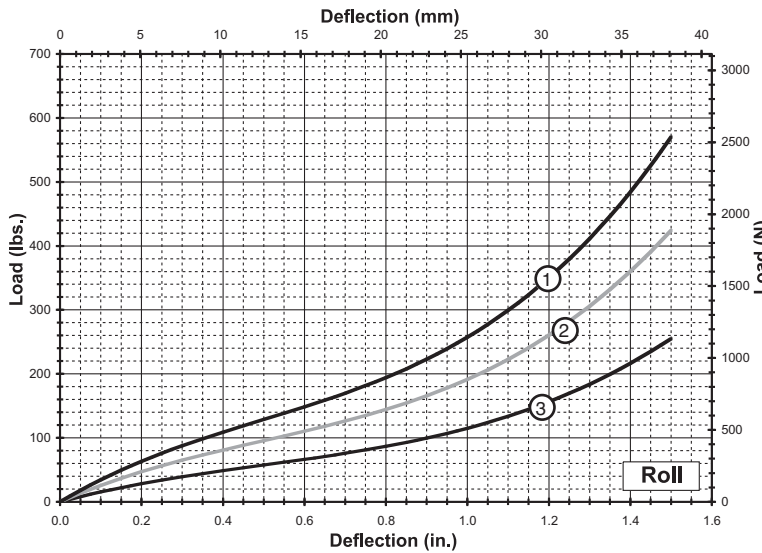

Roll

Curve	Model	Max Static Load Lbs. (N)	Max Deflection in. (mm)	Kv (vibration) Lbs./in. (kN/m)	Ks (shock) Lbs./in. (kN/m)
1	HR12-600	120 (534)	1.50 (38,1)	450 (79)	430 (75)
2	HR12-400	90 (400)	1.50 (38,1)	335 (59)	325 (57)
3	HR12-200	55 (245)	1.50 (38,1)	200 (35)	195 (34)

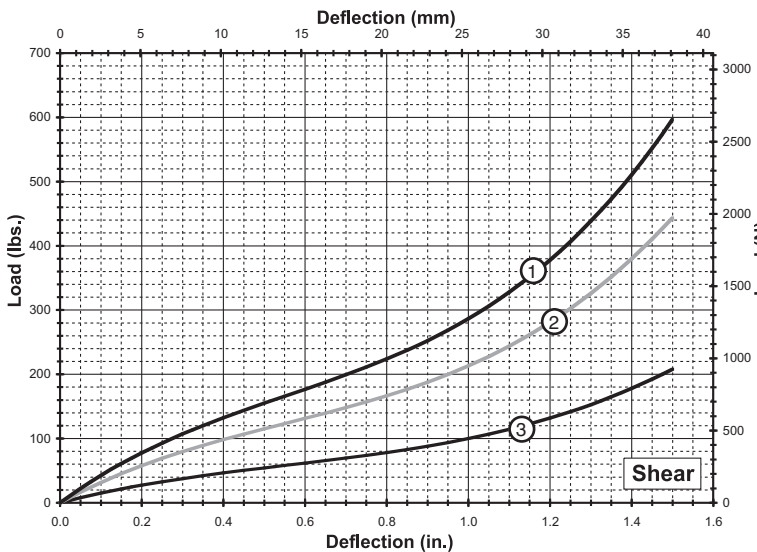

Shear

Curve	Model	Max Static Load Lbs. (N)	Max Deflection in. (mm)	Kv (vibration) Lbs./in. (kN/m)	Ks (shock) Lbs./in. (kN/m)
1	HR12-600	145 (645)	1.50 (38,1)	555 (97)	480 (84)
2	HR12-400	105 (467)	1.50 (38,1)	410 (72)	360 (63)
3	HR12-200	50 (222)	1.50 (38,1)	195 (34)	170 (30)

Note: Do not extrapolate plotted curves.

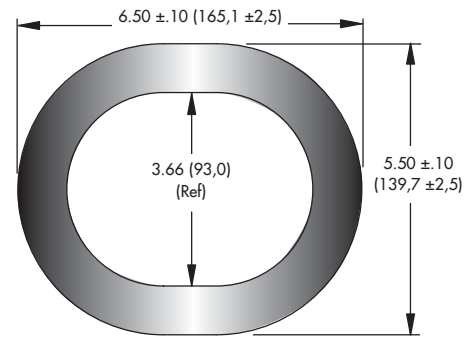
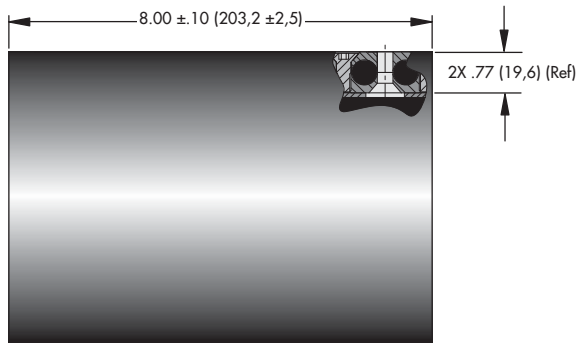
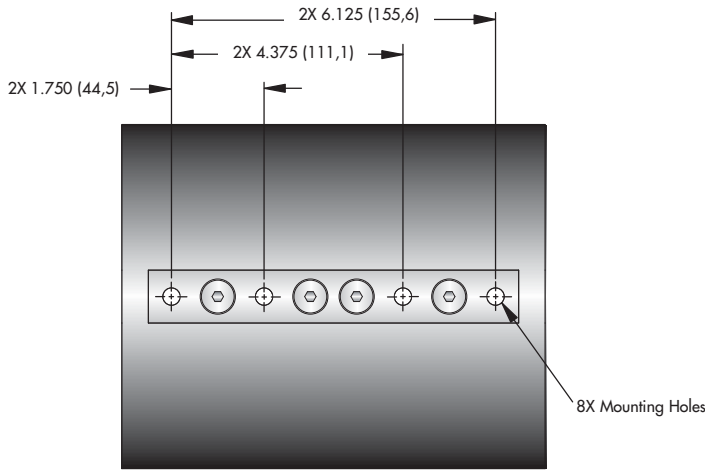

Note: Dimensions are in inches (mm) Tolerances are ± .010 (± .25mm)

Size	Unit Weight lbs. (Kg)	Mounting Option	Thru Hole in. (mm)	C'sink Imperial
HR16-606	8.8 (4,0)	B	∅.328 ^{+0,005} _{-0,015}	82°
HR16-406	7.5 (3,4)			
HR16-206	6.0 (2,7)		(∅8,3 ^{+0,13} _{-0,38})	

Model Number Ordering Code

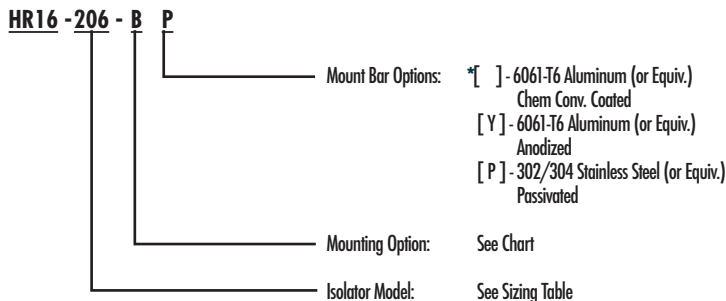

Mounting Option

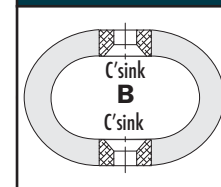

• Meets environmental requirements of MIL-M-17185A

* Standard features. Any non-standard items may require longer lead times. Call for quotation.

Static Load vs. Deflection

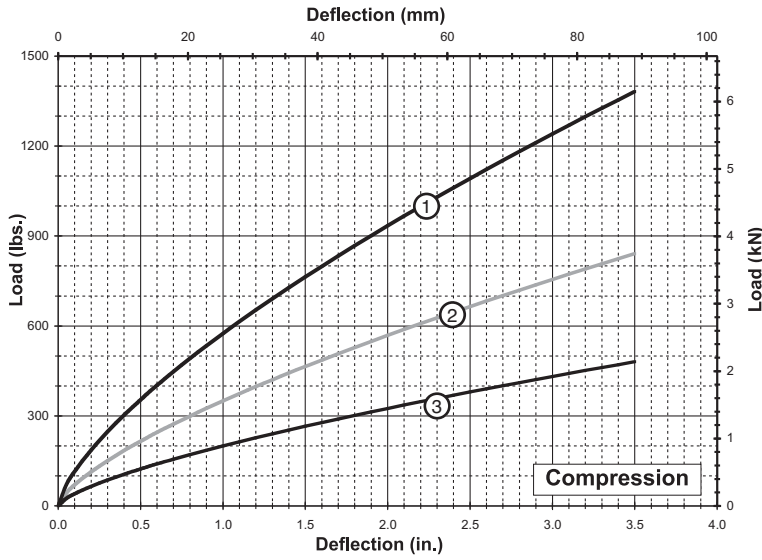

Compression

Curve	Model	Max Static Load Lbs. (N)	Max Deflection in. (mm)	Kv (vibration) Lbs./in. (kN/m)	Ks (shock) Lbs./in. (kN/m)
1	HR16-606	365 (1 624)	3.50 (88,9)	1,490 (261)	700 (123)
2	HR16-406	225 (1 001)	3.50 (88,9)	910 (159)	425 (74)
3	HR16-206	125 (556)	3.50 (88,9)	520 (91)	245 (43)

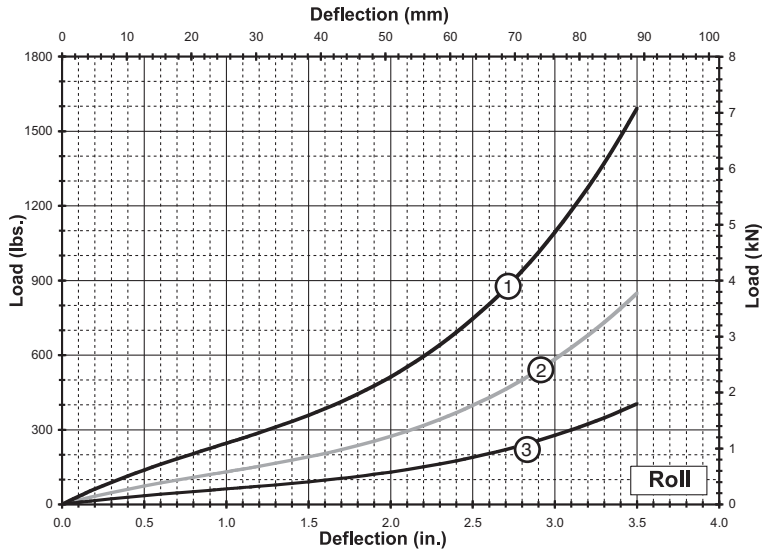

Roll

Curve	Model	Max Static Load Lbs. (N)	Max Deflection in. (mm)	Kv (vibration) Lbs./in. (kN/m)	Ks (shock) Lbs./in. (kN/m)
1	HR16-606	255 (1 134)	3.50 (88,9)	415 (73)	475 (83)
2	HR16-406	135 (601)	3.50 (88,9)	220 (39)	250 (44)
3	HR16-206	65 (289)	3.50 (88,9)	105 (18)	120 (21)

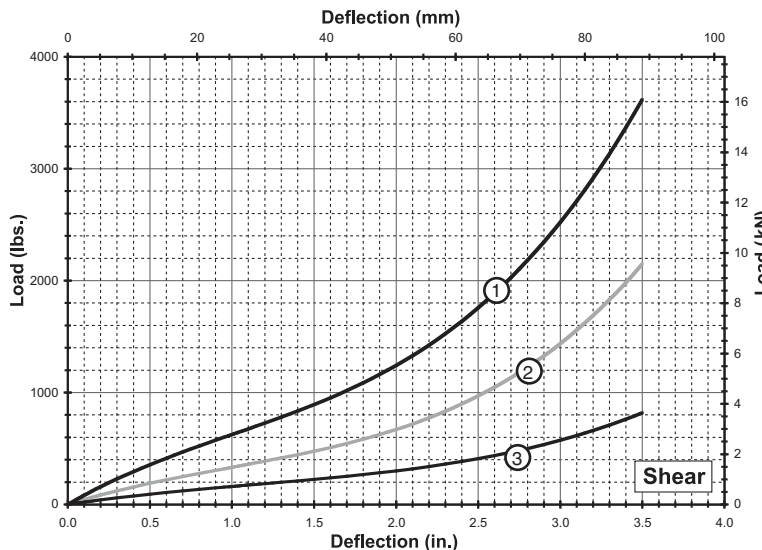

Shear

Curve	Model	Max Static Load Lbs. (N)	Max Deflection in. (mm)	Kv (vibration) Lbs./in. (kN/m)	Ks (shock) Lbs./in. (kN/m)
1	HR16-606	650 (2 891)	3.50 (88,9)	1,065 (187)	1,115 (195)
2	HR16-406	345 (1 535)	3.50 (88,9)	565 (99)	690 (121)
3	HR16-206	165 (734)	3.50 (88,9)	275 (48)	255 (45)

Note: Do not extrapolate plotted curves.

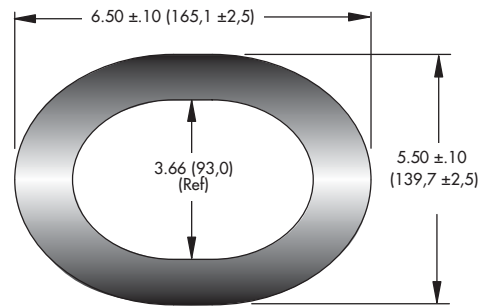
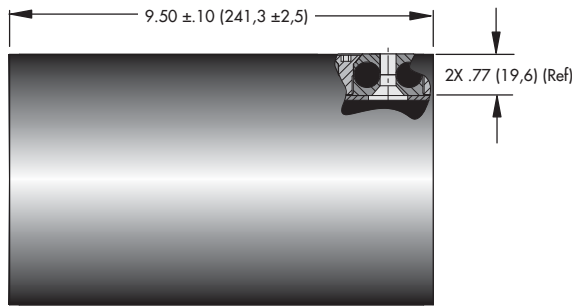
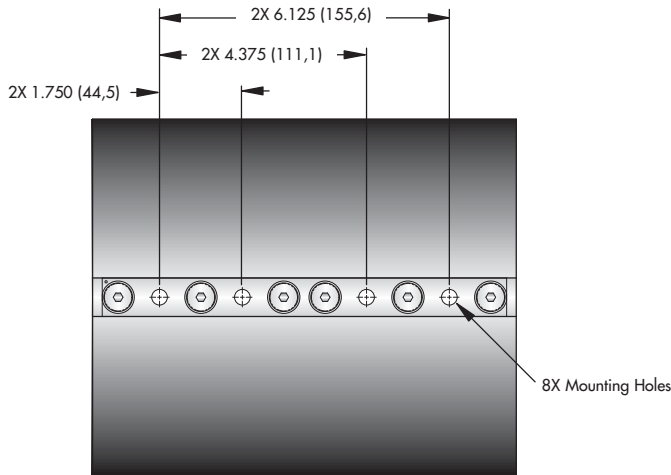

Note: Dimensions are in inches (mm) Tolerances are ± .010 (± .25mm)

Size	Unit Weight lbs. (Kg)	Mounting Option	Thru Hole in. (mm)	C'sink Imperial
HR16-600	10.5 (4,8)	B	∅.328 ^{+0,05} _{-.015}	82°
HR16-400	9.0 (4,1)		(∅8,3 ^{+0,13} _{-0,38})	
HR16-200	7.5 (3,4)			

Model Number Ordering Code

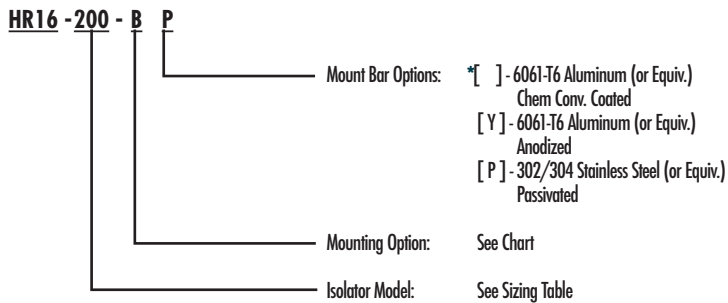

Mounting Option

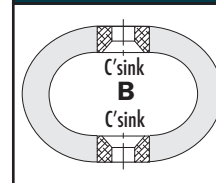

• Meets environmental requirements of MIL-M-17185A

* Standard features. Any non-standard items may require longer lead times. Call for quotation.

Static Load vs. Deflection

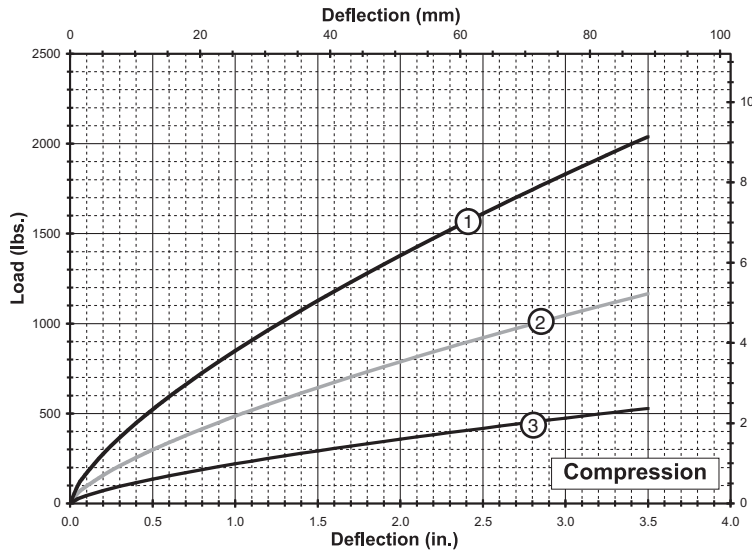

Compression

Curve	Model	Max Static Load Lbs. (N)	Max Deflection in. (mm)	Kv (vibration) Lbs./in. (kN/m)	Ks (shock) Lbs./in. (kN/m)
1	HR16-600	545 (2 424)	3.50 (88,9)	2,220 (389)	1,035 (181)
2	HR16-400	310 (1 379)	3.50 (88,9)	1,260 (221)	590 (103)
3	HR16-200	140 (623)	3.50 (88,9)	570 (100)	270 (47)

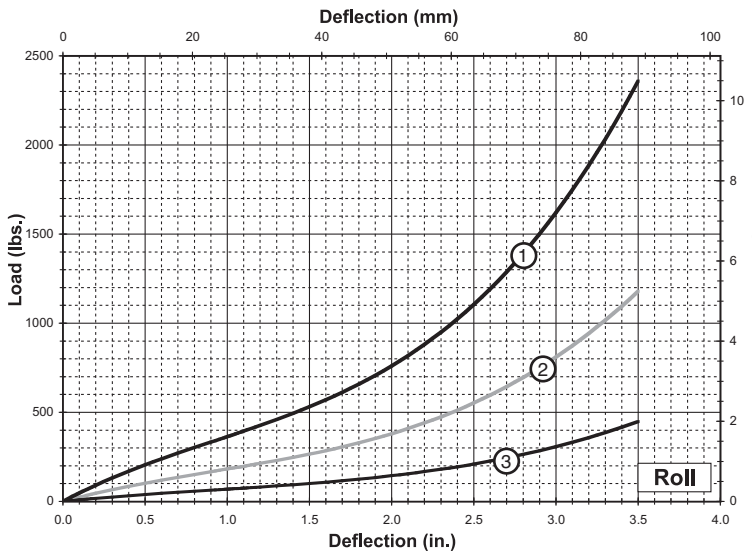

Roll

Curve	Model	Max Static Load Lbs. (N)	Max Deflection in. (mm)	Kv (vibration) Lbs./in. (kN/m)	Ks (shock) Lbs./in. (kN/m)
1	HR16-600	375 (1 668)	3.50 (88,9)	615 (108)	700 (123)
2	HR16-400	185 (823)	3.50 (88,9)	305 (53)	350 (61)
3	HR16-200	70 (311)	3.50 (88,9)	115 (20)	135 (24)

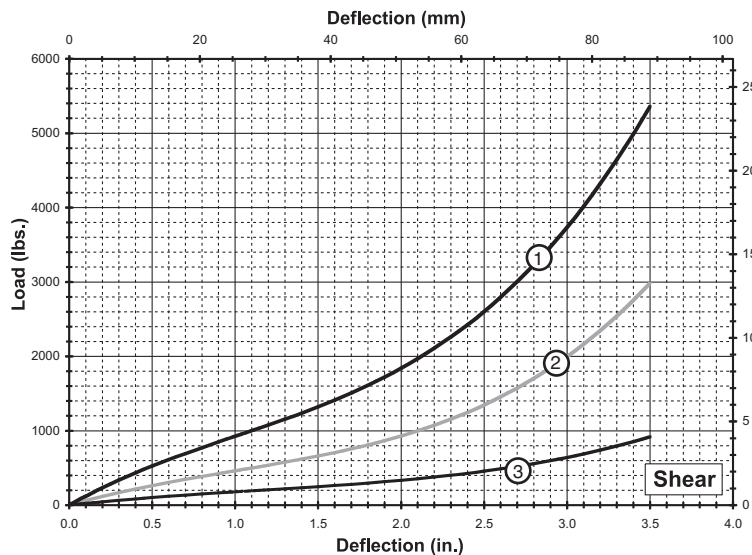

Shear

Curve	Model	Max Static Load Lbs. (N)	Max Deflection in. (mm)	Kv (vibration) Lbs./in. (kN/m)	Ks (shock) Lbs./in. (kN/m)
1	HR16-600	960 (4 270)	3.50 (88,9)	1,575 (276)	1,655 (290)
2	HR16-400	480 (2 135)	3.50 (88,9)	790 (138)	870 (152)
3	HR16-200	185 (823)	3.50 (88,9)	305 (53)	295 (52)

Note: Do not extrapolate plotted curves.

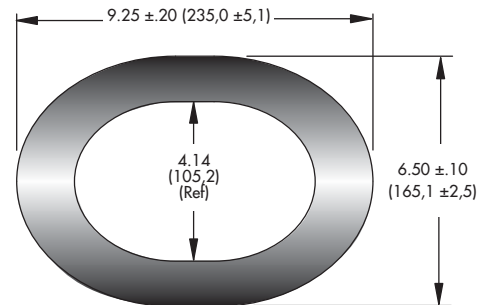
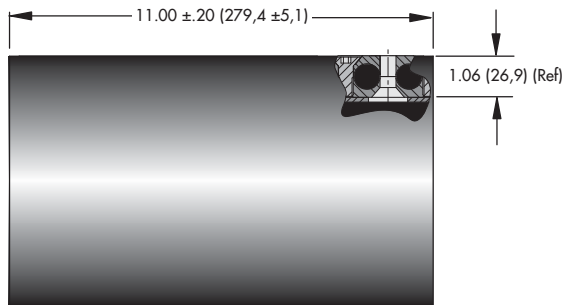
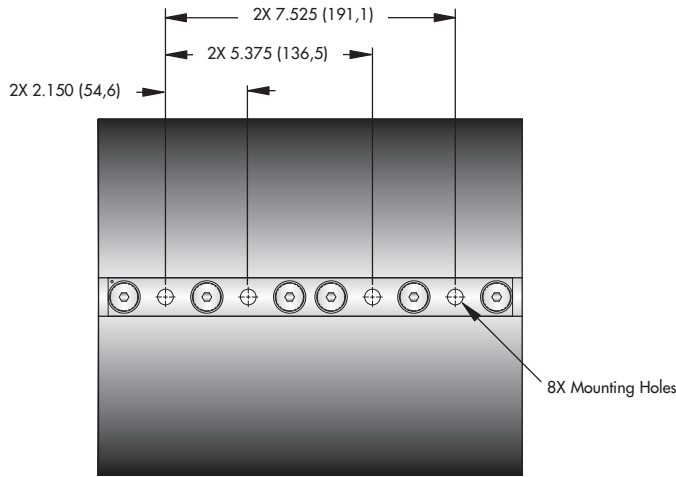

Note: Dimensions are in inches (mm) Tolerances are ± .010 (± .25mm)

Size	Unit Weight lbs. (Kg)	Mounting Option	Thru Hole in. (mm)	C'sink Imperial
HR20-600	21 (9,5)	B	Ø.406 ^{+0,05} _{-0,15}	82°
HR20-400	18 (8,2)			
HR20-200	14 (6,4)		Ø10,3 ^{+0,13} _{-0,38}	

Model Number Ordering Code

HR20 - 200 - B P

Mount Bar Options: * [] - 6061-T6 Aluminum (or Equiv.)
Chem Conv. Coated
[Y] - 6061-T6 Aluminum (or Equiv.)
Anodized
[P] - 302/304 Stainless Steel (or Equiv.)
Passivated

Mounting Option: See Chart

Isolator Model: See Sizing Table

Mounting Option

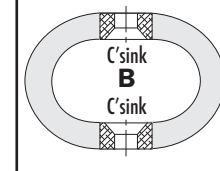

• Meets environmental requirements of MIL-M-17185A

* Standard features. Any non-standard items may require longer lead times. Call for quotation.

Static Load vs. Deflection

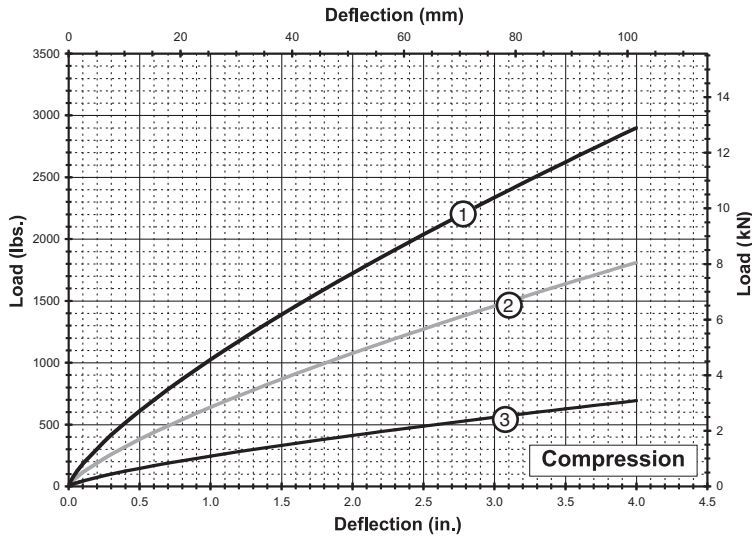

Compression

Curve	Model	Max Static Load Lbs. (N)	Max Deflection in. (mm)	Kv (vibration) Lbs./in. (kN/m)	Ks (shock) Lbs./in. (kN/m)
1	HR20-600	700 (3 114)	4.00 (101,6)	2,370 (415)	1,245 (218)
2	HR20-400	435 (1 935)	4.00 (101,6)	1,480 (259)	777 (136)
3	HR20-200	165 (734)	4.00 (101,6)	565 (99)	295 (52)

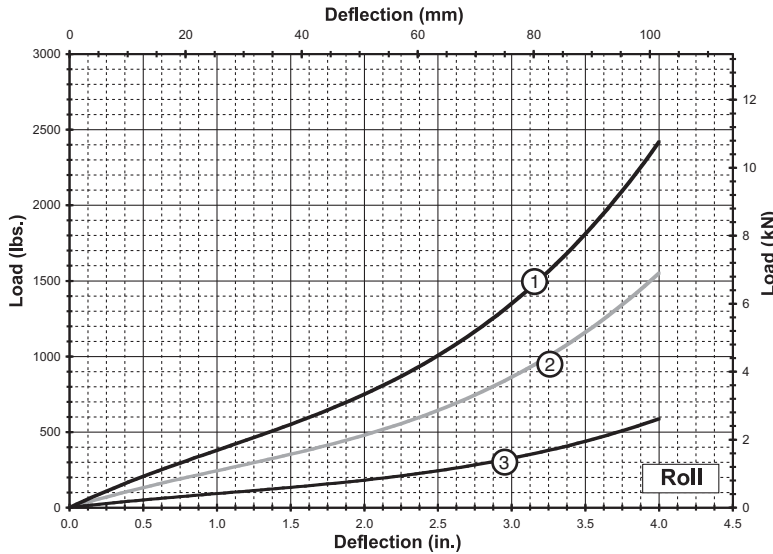

Roll

Curve	Model	Max Static Load Lbs. (N)	Max Deflection in. (mm)	Kv (vibration) Lbs./in. (kN/m)	Ks (shock) Lbs./in. (kN/m)
1	HR20-600	360 (1 601)	4.00 (101,6)	590 (103)	675 (118)
2	HR20-400	230 (1 023)	4.00 (101,6)	380 (67)	435 (76)
3	HR20-200	90 (400)	4.00 (101,6)	145 (25)	165 (29)

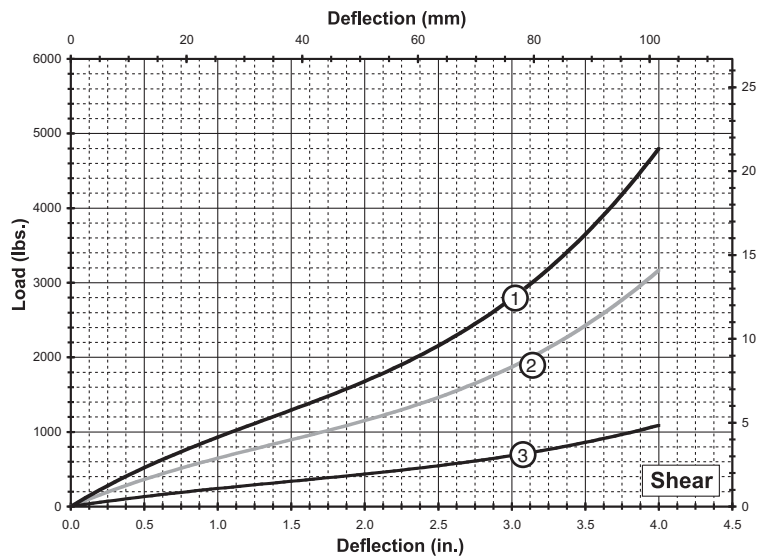

Shear

Curve	Model	Max Static Load Lbs. (N)	Max Deflection in. (mm)	Kv (vibration) Lbs./in. (kN/m)	Ks (shock) Lbs./in. (kN/m)
1	HR20-600	925 (4 115)	4.00 (101,6)	1,515 (265)	1,440 (252)
2	HR20-400	645 (2 869)	4.00 (101,6)	1,060 (186)	970 (170)
3	HR20-200	230 (1 023)	4.00 (101,6)	380 (67)	355 (62)

Note: Do not extrapolate plotted curves.

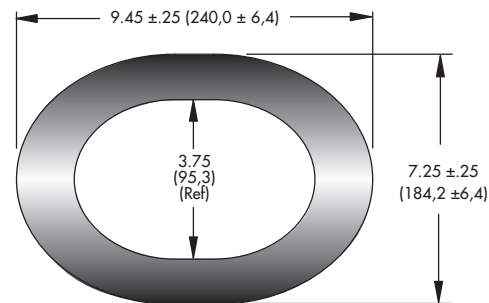
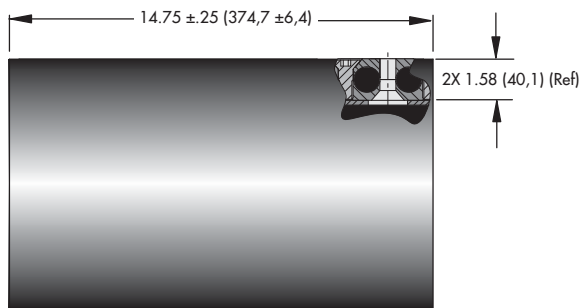
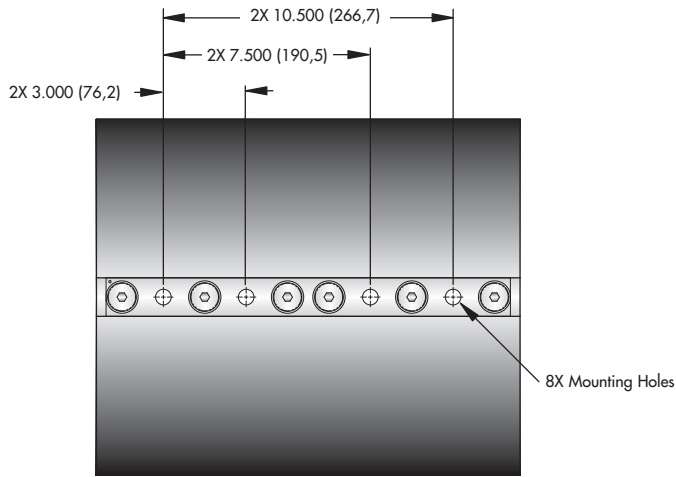

Note: Dimensions are in inches (mm) Tolerances are ± .010 (± .25mm)

Size	Unit Weight lbs. (Kg)	Mounting Option	Thru Hole in. (mm)	C'sink Imperial
HR28-600	50 (23)	B	Ø.531 ^{+0,05} _{-.015}	82°
HR28-400	40 (18)			
HR28-200	30 (14)		Ø13,5 ^{+0,13} _{-0,38}	

Model Number Ordering Code

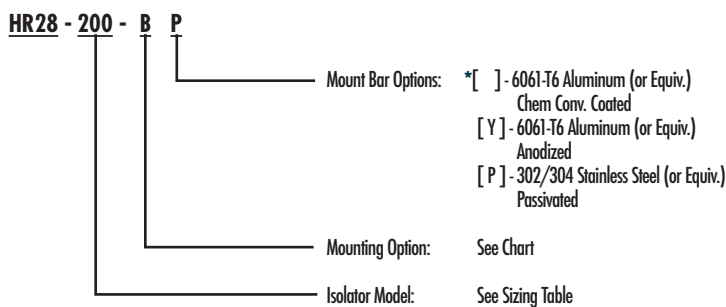

Mounting Option

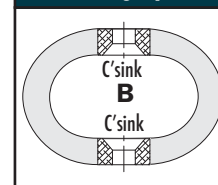

* Standard features. Any non-standard items may require longer lead times. Call for quotation.

Static Load vs. Deflection

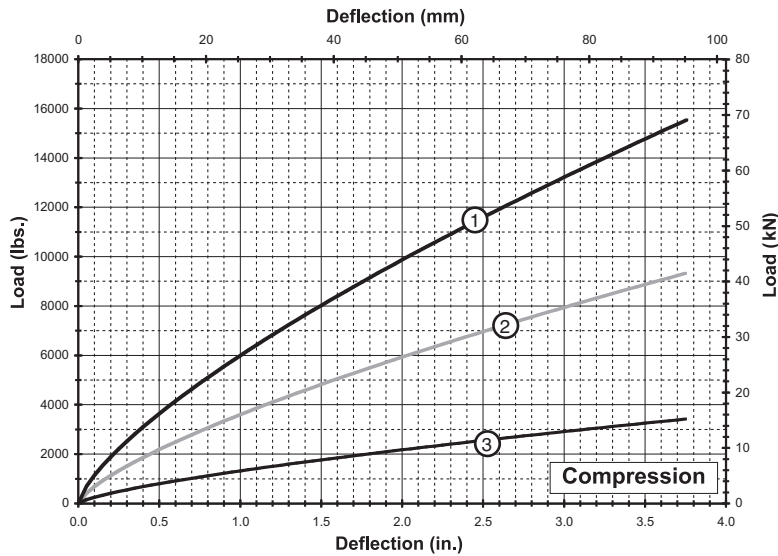

Compression

Curve	Model	Max Static Load Lbs. (kN)	Max Deflection in. (mm)	Kv (vibration) Lbs./in. (kN/m)	Ks (shock) Lbs./in. (kN/m)
1	HR28-600	4,000 (17,79)	3.75 (95,3)	14,865 (2 603)	7,230 (1 266)
2	HR28-400	2,375 (10,56)	3.75 (95,3)	8,920 (1 562)	4,335 (759)
3	HR28-200	870 (3,87)	3.75 (95,3)	3,270 (573)	1,590 (278)

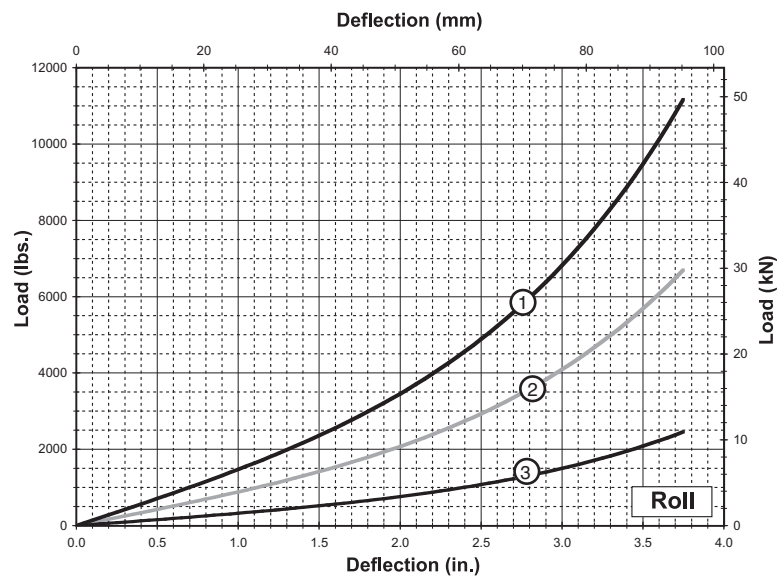

Roll

Curve	Model	Max Static Load Lbs. (kN)	Max Deflection in. (mm)	Kv (vibration) Lbs./in. (kN/m)	Ks (shock) Lbs./in. (kN/m)
1	HR28-600	1,110 (4,94)	3.75 (95,3)	1,820 (319)	3,135 (549)
2	HR28-400	670 (2,98)	3.75 (95,3)	1,095 (192)	1,880 (329)
3	HR28-200	245 (1,09)	3.75 (95,3)	400 (70)	690 (121)

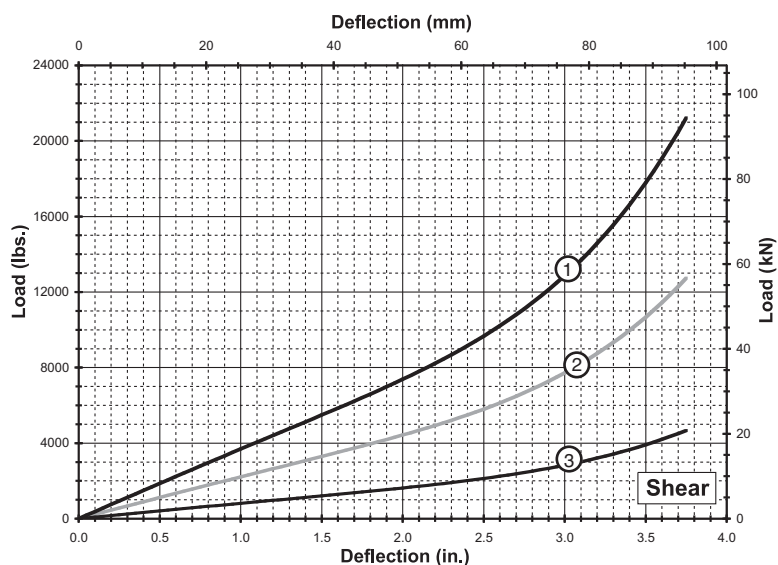

Shear

Curve	Model	Max Static Load Lbs. (kN)	Max Deflection in. (mm)	Kv (vibration) Lbs./in. (kN/m)	Ks (shock) Lbs./in. (kN/m)
1	HR28-600	2,980 (13,26)	3.75 (95,3)	4,875 (854)	6,315 (1 106)
2	HR28-400	1,790 (7,96)	3.75 (95,3)	2,925 (512)	3,790 (664)
3	HR28-200	655 (2,91)	3.75 (95,3)	1,070 (187)	1,395 (244)

Note: Do not extrapolate plotted curves.

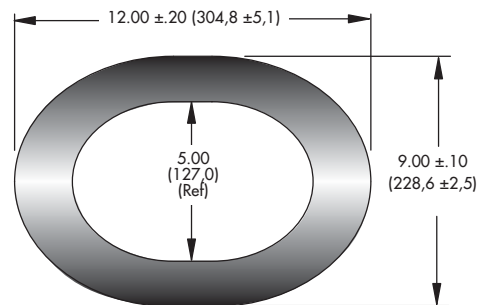
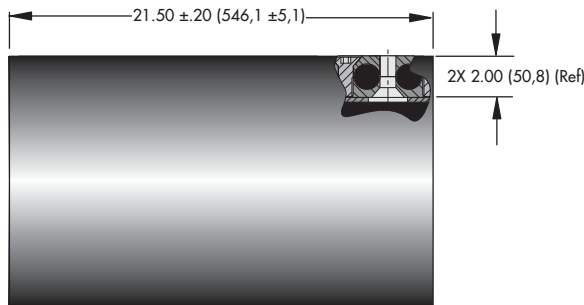
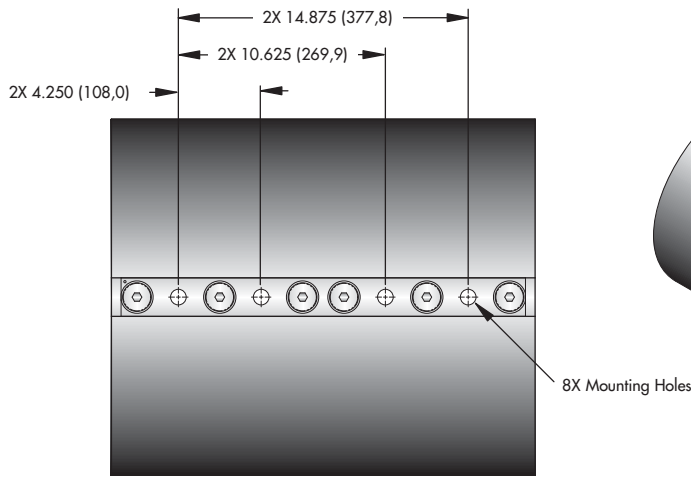

Note: Dimensions are in inches (mm) Tolerances are ± .010 (± .25mm)

Size	Unit Weight lbs. (Kg)	Mounting Option	Thru Hole in. (mm)	C'sink Imperial
HR40-600	100 (45)	B	0.781 ^{+.005} _{-.015}	82°
HR40-400	83 (38)			
HR40-200	67 (30)		(0.781 ^{+.013} _{-.038})	

Model Number Ordering Code

HR40 - 200 - B P

Mount Bar Options: * [] - 6061-T6 Aluminum (or Equiv.)
Chem Conv. Coated
[Y] - 6061-T6 Aluminum (or Equiv.)
Anodized
[P] - 302/304 Stainless Steel (or Equiv.)
Passivated

Mounting Option: See Chart

Isolator Model: See Sizing Table

Mounting Option

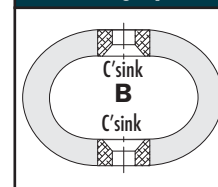

• Meets environmental requirements of MIL-M-17185A

* Standard features. Any non-standard items may require longer lead times. Call for quotation.

Static Load vs. Deflection

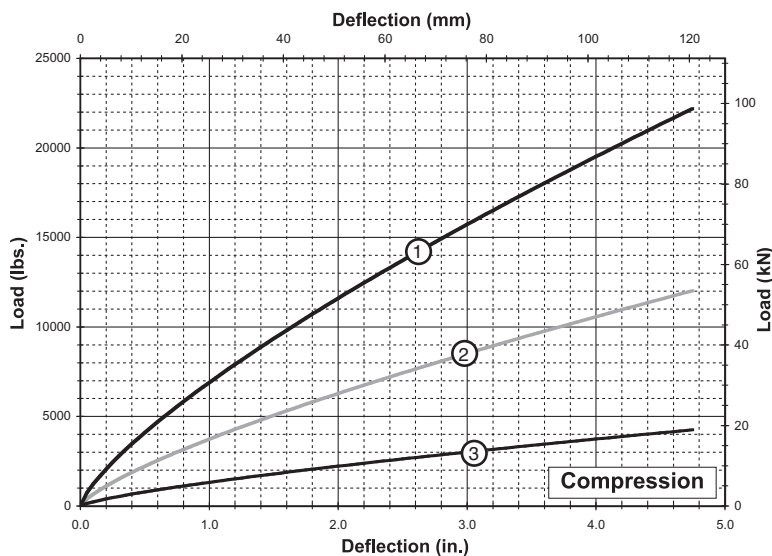

Compression

Curve	Model	Max Static Load Lbs. (kN)	Max Deflection in. (mm)	Kv (vibration) Lbs./in. (kN/m)	Ks (shock) Lbs./in. (kN/m)
1	HR40-600	5,350 (23,80)	4.75 (120,7)	15,950 (2 793)	8,010 (1 403)
2	HR40-400	2,900 (12,90)	4.75 (120,7)	8,640 (1 513)	4,340 (760)
3	HR40-200	1,025 (4,56)	4.75 (120,7)	3,055 (535)	1,535 (269)

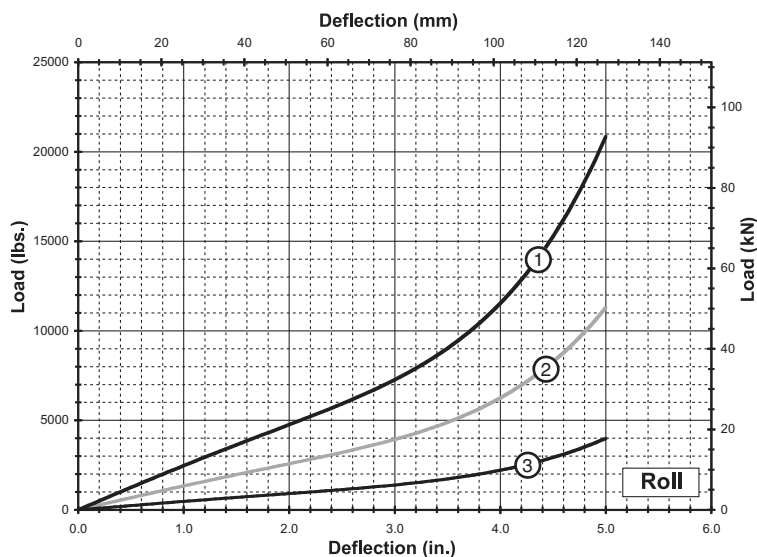

Roll

Curve	Model	Max Static Load Lbs. (kN)	Max Deflection in. (mm)	Kv (vibration) Lbs./in. (kN/m)	Ks (shock) Lbs./in. (kN/m)
1	HR40-600	2,000 (8,90)	5.00 (127)	3,275 (574)	4,330 (758)
2	HR40-400	1,085 (4,83)	5.00 (127)	1,775 (311)	2,440 (427)
3	HR40-200	385 (1,71)	5.00 (127)	630 (110)	850 (149)

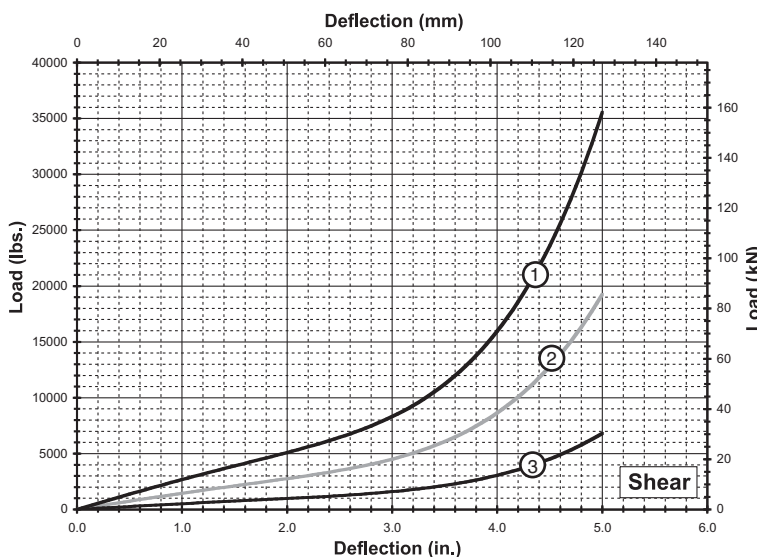

Shear

Curve	Model	Max Static Load Lbs. (kN)	Max Deflection in. (mm)	Kv (vibration) Lbs./in. (kN/m)	Ks (shock) Lbs./in. (kN/m)
1	HR40-600	2,190 (9,74)	5.00 (127)	3,585 (628)	5,780 (1 012)
2	HR40-400	1,190 (5,29)	5.00 (127)	1,945 (341)	3,145 (551)
3	HR40-200	420 (1,87)	5.00 (127)	685 (120)	1,080 (189)

Note: Do not extrapolate plotted curves.



WEAR™ (Wire Energy Absorbing Rope) pipe restraints are uniquely packaged wire rope isolators designed to protect structures from steady state vibration and isolate them from seismic and dynamic loads. These new generation energy absorbing restraints feature simple construction. There are no oils, seals or complex moving parts required to perform their function. The design has eliminated the problems often associated with hydraulic or mechanical restraints which are complex and prone to failure.

The Wire Rope Isolator, which is the basic element of the technology has been successfully used by the military for more than 25 years. As a result, it conforms to government and military quality control requirements. The restraint is thus exempt from surveillance testing. In-place visual inspection is all that is required to assure operability. The WEAR™ can be provided with a wide range of piping accessories and can be supplied to ISO 9001, Mil-Q, Mil-I, B31.1 or ASME Section III subsection NF.

Options Available

Various end connections are available to meet existing hardware such as Bergen Paterson, Basic Engineers, PSA, Grinnel and others. For sizing or specific application information, call your local representative or Enidine directly.

Typical Applications

- Pipe Restraint
- Hydraulic Transients
- Power Generating Plants
- Chemical Plants
- Seismic Restraints
- Steady State Vibration
- Nuclear Plants
- Refineries
- Structural Vibration
- Wind Loading
- Pulp and Paper Mills

WEAR™ Benefits

- Repeatable
- Environmentally Stable
- Low Structural Loading
- Dissipate Energy
- Wide Operating Temperature Range
- Proven Technology
- Simple Construction
- Corrosion Resistant
- High Cycle Fatigue Life
- No Maintenance

Environmental Conditions

Normal Temperature:	-40°F to 200°F / -40°C to 100°C
Faulted Temperature:	-40°F to 350°F / -40°C to 175°C
Humidity:	100% RH
Radiation:	1 x 10 ⁹ RAD
Pressure:	-14.7 psi to 100 psi 0 atm to 7 atm

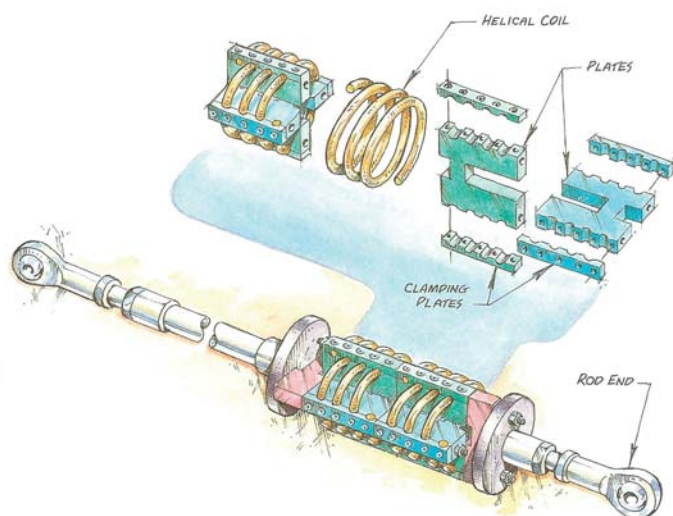
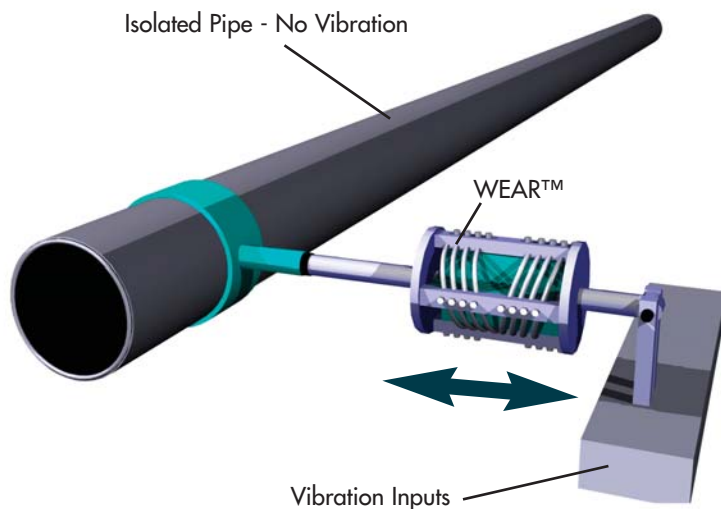

Captured every quarter loop, wire rope coil will not collapse; two-pitch design prevents twisting.



Wire Mesh Isolators

Wire mesh material can be manufactured in a multitude of shapes and sizes to accommodate your specific application. When exercised, the wire mesh damping elements convert input energy to heat. Friction is created when knitted or woven stainless steel wire strands are displaced relative to one another. Knitted metals have inherent resiliency and provide high-damping characteristics and non-linear spring rates.

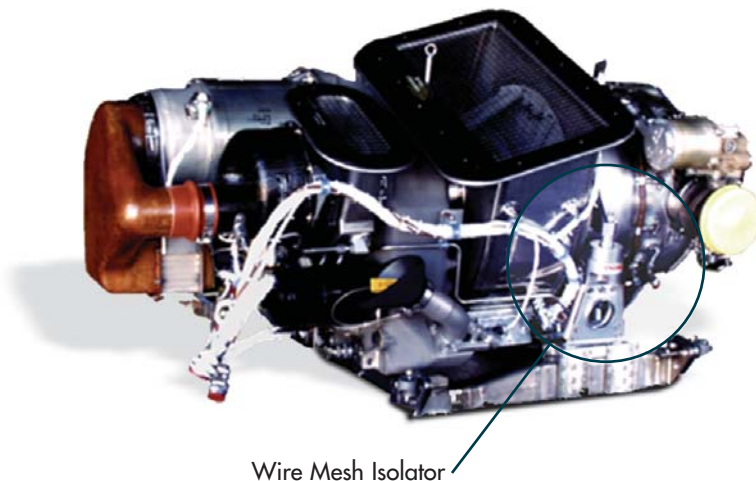

Wire Mesh Isolator

Wire Mesh Isolator Features:

- Wide operating temperature range
- Long service life
- Environmental compatibility
- Maintenance-free operation
- Custom sizes and shapes available

Wire Mesh Isolator Typical Applications:

- Auxiliary Power Units
- Engines
- Communications Equipment
- Medical Equipment
- Sensitive Mobile Electronics

Material Development:

If your application parameters fall outside of the standard product line, you can be sure that Enidine has the engineering capabilities and resources to design, test and recommend a custom solution to suit your specific needs:

- 3D Modeling
- System Analysis (Modal, Linear/Non-Linear, Dynamic Analysis and Simulation, Finite Element, Shock and Vibration)
- In-house test facility for prototypes and production models: Static Load/Deflection, Life Cycle, Vibration Frequency, Dynamic Load, Random Input and High Frequency Noise
- AS-9100 Certified
- ISO 9001 Certified



WR and HERM Applications:

- Avionics
- Carts, Transporters & Gurneys
- Chemical Processing Equipment
- Electronic Cabinets
- Military Equipment
- Navigation Equipment
- Over-the-road Transport
- Pump, Generator & Compressor Isolation
- Shipboard Electronics
- Shipping Cases, Skids & Containers
- Transportable Shelters
- Ground Support Equipment
- Engine Stands
- Shipboard Shock (Mil-S-901D)
- Galley and Lavatory Equipment
- Piping and Ducting

CR Applications:

- Audio/Visual Equipment
- Catering Carts
- Communications Packages
- Medical Devices
- Sensitive Electronic Equipment
- Security Cameras
- Hard Drives / CD-ROM Drives
- Electronics Production
- Optical Sensors
- Mobile Electronics (Mil-Std-810E)
- Displays



Enidine Incorporated

7 Centre Drive
Orchard Park, New York 14127
USA
Phone: 716-662-1900
Fax: 716-667-1385
Email: defensesales@itt.com
www.enidine-defense.com

Enidine Europe

P.O. Box 8890
Coalville
LE67 0BU
United Kingdom
Phone: +44 (0) 844 736 5941
Fax: +44 (0) 844 736 5913
Email: defensesales@itt.com
www.enidine-defense.com